



INSTRUCTION MANUAL

MF/HF MARINE TRANSCEIVER **IC-M803**



This device complies with Part 15 of the FCC rules. Operation is subject to the following two conditions: (1) This device may not cause harmful interference, and (2) this device must accept any interference received, including interference that may cause undesired operation.

Thank you for choosing this Icom product. This product is designed and built with Icom's state of the art technology and craftsmanship. With proper care, this product should provide you with years of trouble-free operation.

IMPORTANT

READ ALL INSTRUCTIONS carefully completely before using the transceiver.

SAVE THIS INSTRUCTION MANUAL— This instruction manual contains important operating instructions for the IC-M803.

This instruction manual includes some functions that are usable only when your dealer preset them. Ask your dealer for details.

EXPLICIT DEFINITIONS

WORD	DEFINITION
⚠ DANGER!	Personal death, serious injury, or an explosion may occur.
⚠ WARNING!	Personal injury, fire hazard, or electric shock may occur.
CAUTION	Equipment damage may occur.
NOTE	If disregarded, inconvenience only. No risk of personal injury, fire or electric shock.

Icom is not responsible for the destruction, damage to, or performance of any Icom or Non-Icom equipment, if the malfunction is because of:

- Force majeure, including, but not limited to, fires, earthquakes, storms, floods, lightning, other natural disasters, disturbances, riots, war, or radioactive contamination.
- The use of Icom transceivers with any equipment that is not manufactured or approved by Icom.

Icom, Icom Inc. and the Icom logo are registered trademarks of Icom Incorporated (Japan) in Japan, the United States, the United Kingdom, Germany, France, Spain, Russia, Australia, New Zealand, and/or other countries.

IN CASE OF EMERGENCY

If your vessel requires assistance, contact other vessels and the Coast Guard by sending a distress call using DSC (digital selective calling) on an emergency frequency.

When immediate help is needed:

1. Lift the key cover, hold down [DISTRESS] for 3 seconds until the 3 short beeps and then one long beep sound.
2. Wait for an acknowledgment from another station.
3. After the acknowledgment is received, hold down [PTT] on the microphone and send the following information.
 - 1 "MAYDAY, MAYDAY, MAYDAY."
 - 2 "THIS IS (name of the vessel)."
 - 3 "LOCATED AT (vessel's position)."
 - 4 Give the reason for the distress call.
 - 5 Explain what assistance you need.
 - 6 Give additional information about your vessel:
 - Type
 - Length
 - Color
 - The number of people on board

FEATURES

- Meets the latest ITU-R M.493-13 DSC
- IPX7 water proof construction (remote controller only)
- Easy user interface

The remote controller has the 4.3 inches wide viewing angle, and the color display with Day and Night modes.
- Automatic Voice Recording function

Records the last 120 seconds (max.) of receiving audio.
- Independent Emergency channels

Monitor Distress voice frequencies.
- Built-in Class E DSC function

The transceiver has the DSC functions for distress alert transmission and reception, as well as the general DSC calls such as Individual calls, Group calls, and so on.
- Built-in GPS receiver
- NMEA 0183 (4800 to 38400 bps) available
- AT-130/AT-140 optional antenna tuner
- 150 W of powerful output power
- RF Direct Sampling system employed

RADIO OPERATION WARNING



WARNING

Icom requires the radio operator to meet the FCC Requirements for Radio Frequency Exposure. An omnidirectional antenna with gain not greater than 9 dBi must be mounted a minimum of 7.5 meters (measured from the lowest point of the antenna) vertically above the main deck and all possible personnel. This is the minimum safe separation distance estimated to meet all RF exposure compliance requirements. This 7.5 meter distance is based on the FCC Safe Maximum Permissible Exposure (MPE) distance of 5.5 meters added to the height of an adult (2 meters) and is appropriate for all vessels.

For watercraft without suitable structures, the antenna must be mounted so as to maintain a minimum of 1 meter vertically between the antenna, (measured from the lowest point of the antenna), to the heads of all persons AND all persons must stay outside of the 5.5 meter MPE radius.

Do not transmit with radio and antenna when persons are within the MPE radius of the antenna, unless such persons (such as driver or radio operator) are shielded from antenna field by a grounded metallic barrier. The MPE Radius is the minimum distance from the antenna axis that person should maintain in order to avoid RF exposure higher than the allowable MPE level set by FCC.

FAILURE TO OBSERVE THESE LIMITS MAY ALLOW THOSE WITHIN THE MPE RADIUS TO EXPERIENCE RF RADIATION ABSORPTION WHICH EXCEEDS THE FCC MAXIMUM PERMISSIBLE EXPOSURE (MPE) LIMIT. IT IS THE RESPONSIBILITY OF THE RADIO OPERATOR TO ENSURE THAT THE MAXIMUM PERMISSIBLE EXPOSURE LIMITS ARE OBSERVED AT ALL TIMES DURING RADIO TRANSMISSION. THE RADIO OPERATOR IS TO ENSURE THAT NO BYSTANDERS COME WITHIN THE RADIUS OF THE MAXIMUM PERMISSIBLE EXPOSURE LIMITS.

**Determining MPE Radius
THE MAXIMUM PERMISSIBLE EXPOSURE (MPE) RADIUS HAS BEEN ESTIMATED TO BE A RADIUS OF ABOUT 5.5M PER OET BULLETIN 65 OF THE FCC.
THIS ESTIMATE IS MADE ASSUMING THE MAXIMUM POWER OF THE RADIO AND ANTENNAS WITH A MAXIMUM GAIN OF 9dBi ARE USED FOR A SHIP MOUNTED SYSTEM.**

AVERTISSEMENT POUR LES OPÉRATEURS RADIO



AVERTISSEMENT

Icom exige que l'opérateur radio se conforme aux exigences de la FCC en matière d'exposition aux radiofréquences. Une antenne omnidirectionnelle dont le gain ne dépasse pas 9dBi doit être fixée à une distance minimale de 7.5 mètres (mesurée depuis le point le plus bas de l'antenne) verticalement au-dessus du pont principal et de tout le personnel qui peut s'y trouver. Il s'agit de la distance de sécurité minimale prévue pour satisfaire aux exigences de conformité en matière d'exposition aux RF. Cette distance de 7.5 mètres est établie en fonction de l'exposition maximale admissible sécuritaire de 5.5 mètres établie par la FCC, à laquelle on ajoute la hauteur d'un adulte (2 mètres); cette distance convient pour tous les navires.

Dans le cas des embarcations sans structure convenable, l'antenne doit être fixée de façon à maintenir une distance minimale de 1 mètre verticalement entre cette antenne (mesurée depuis son point le plus bas) et la tête de toute personne présente; toutes les personnes présentes doivent se tenir à l'extérieur d'un rayon d'exposition maximale admissible de 5.5 mètres.

Ne pas émettre à l'aide de la radio et de l'antenne lorsque des personnes se trouvent à l'intérieur du rayon d'exposition maximale admissible de cette antenne, à moins que ces personnes (comme le conducteur ou l'opérateur radio) ne soient protégées du champ de l'antenne par un écran métallique relié à la masse. Le rayon d'exposition maximale admissible équivaut à la distance minimale que cette personne doit maintenir entre elle et l'axe de l'antenne pour éviter une exposition aux RF supérieure au niveau d'exposition maximale admissible fixé par la FCC.

LE NON-RESPECT DE CES LIMITES PEUT CAUSER, POUR LES PERSONNES SITUÉES DANS LE RAYON D'EXPOSITION MAXIMALE ADMISSIBLE, UNE ABSORPTION DE RAYONNEMENT DE RF SUPÉRIEURE À L'EXPOSITION MAXIMALE ADMISSIBLE FIXÉE PAR LA FCC. L'OPÉRATEUR RADIO EST RESPONSABLE D'ASSURER QUE LES LIMITES D'EXPOSITION MAXIMALE ADMISSIBLE SOIENT RESPECTÉES EN TOUT TEMPS PENDANT LA TRANSMISSION RADIO. L'OPÉRATEUR RADIO DOIT S'ASSURER QU'AUCUNE PERSONNE PRÉSENTE NE SE SITUE À L'INTÉRIEUR DU RAYON D'EXPOSITION MAXIMALE ADMISSIBLE.

**Établir le rayon d'exposition maximale admissible
ON ESTIME QUE LE RAYON D'EXPOSITION MAXIMALE ADMISSIBLE EST D'ENVIRON 5.5M, TEL QUE STIPULÉ DANS LE BULLETIN OET 65 DE LA FCC. CETTE DISTANCE ESTIMÉE TIENT COMPTE D'UN SYSTÈME INSTALLÉ SUR UN NAVIRE UTILISANT LA PUISSANCE MAXIMALE DE LA RADIO ET DES ANTENNES DONT LE GAIN MAXIMAL EST DE 9dBi.**

FCC INFORMATION

This equipment has been tested and found to comply with the limits for a Class A digital device, pursuant to part 15 of the FCC Rules. These limits are designed to provide reasonable protection against harmful interference when the equipment is operated in a commercial environment. This equipment generates, uses, and can radiate radio frequency energy and, if not installed and used in accordance with the instruction manual, may cause harmful interference to radio communications.

Operation of this equipment in a residential area is likely to cause harmful interference in which case the user will be required to correct the interference at his own expense.

CAUTION: Changes or modifications to this transceiver, not expressly approved by Icom Inc., could void your authority to operate this transceiver under FCC regulations.

INFORMATION FCC

Cet équipement a été testé et reconnu conforme aux limites fixées pour un appareil numérique de classe A, conformément au point 15 de la réglementation FCC. Ces limites sont définies de façon à fournir une protection raisonnable contre le brouillage préjudiciable lorsque cet appareil est utilisé dans un environnement commercial. Cet équipement génère, utilise et peut émettre un rayonnement de fréquence radio. S'il n'a pas été installé conformément aux instructions, il peut par ailleurs créer des interférences perturbant les communications radio.

L'utilisation de cet appareil dans une zone résidentielle peut provoquer un brouillage préjudiciable, auquel cas l'utilisateur sera tenu de corriger la situation à ses frais.

MISE EN GARDE: Tout changement ou modification, non expressément approuvé par Icom Inc., peut annuler l'autorisation de l'utilisateur à utiliser cet appareil conformément à la réglementation FCC.

PERCAUTIONS

⚠ **DANGER HIGH RF VOLTAGE! NEVER** touch an antenna while transmitting. This may result in an electrical shock or burn.

⚠ **WARNING! NEVER** operate the transceiver during a lightning storm. It may result in an electric shock, cause a fire, or damage the transceiver. Always disconnect the power source and antenna before a storm.

⚠ **WARNING! NEVER** connect the transceiver directly to an AC outlet. This may pose a fire hazard or result in an electric shock.

⚠ **WARNING! NEVER** mount the transceiver's main unit overhead. The weight of the main unit is approximately 4.41 kg (9.7 lb), and it could easily fall due to wave shocks or vibration. The unit must be mounted on a flat hard surface only.

⚠ **WARNING! NEVER** connect a power source of more than 16 V DC. This connection could cause a fire or ruin the transceiver.

⚠ **WARNING! NEVER** reverse the DC power cable polarity. This could cause a fire or damage the equipment.

⚠ **WARNING! NEVER** remove the fuse holder on the DC power cable. Excessive current caused by a short could cause a fire or damage the transceiver.

⚠ **WARNING! NEVER** place the transceiver where normal operation of the vessel may be hindered, or where it could cause bodily injury.

⚠ **WARNING! NEVER** let metal, wire or other objects protrude the transceiver or into connectors on the rear panel. This may result in an electric shock.

CAUTION: DO NOT use harsh solvents such as benzine or alcohol when cleaning, because they will damage the transceiver's surfaces.

CAUTION: DO NOT use the transceiver in areas with temperatures out of the range of $-20^{\circ}\text{C} \sim +55^{\circ}\text{C}$ ($-4^{\circ}\text{F} \sim +131^{\circ}\text{F}$).

CAUTION: DO NOT place the transceiver in excessively dusty environments or direct sunlight.

CAUTION: DO NOT use non-Icom microphones. Other manufacturer's microphones have different pin assignments, and connection to the transceiver may damage the transceiver.

CAUTION: DO NOT place the transceiver against walls or putting anything on top of the transceiver. This may overheat the transceiver.

BE CAREFUL! The transceiver's main unit will become hot when operating the transceiver continuously for long periods.

BE CAREFUL! The remote controller's front panel meets IPX7 requirements for waterproof protection. However, once the transceiver has been dropped, or the waterproof seal is cracked or damaged, waterproof protection cannot be guaranteed because of possible damage to the case or the waterproof seal.
① The connectors on the rear panel do not meet IPX7.

NOTE: The LCD may have cosmetic imperfections that appear as small dark or light spots. This is not a malfunction or defect, but a normal characteristic of LCDs.

NOTE: Install the transceiver and microphone more than 1 meter (3.3 ft) from the vessel's magnetic navigation compass.

NOTE: Always place the unit in a secure place to avoid inadvertent use by unauthorized persons.

PRÉCAUTIONS

⚠ **DANGER TENSION À HAUTES RF ! NE JAMAIS** toucher l'antenne pendant une transmission. Cela risquerait de provoquer un choc électrique ou des brûlures.

⚠ **AVERTISSEMENT ! NE JAMAIS** utiliser l'émetteur-récepteur durant un orage. Cela risquerait de provoquer un choc électrique, un incendie ou d'endommager l'émetteur-récepteur. Toujours débrancher la source d'alimentation et l'antenne avant une tempête.

⚠ **AVERTISSEMENT ! NE JAMAIS** brancher directement l'émetteur-récepteur sur une prise de courant alternatif. Cela pourrait provoquer un choc électrique ou un incendie.

⚠ **AVERTISSEMENT ! NE JAMAIS** monter l'unité principale de l'émetteur-récepteur au-dessus de la tête. Le poids de l'unité est d'environ 4.41 kg (9.7 lb), et elle pourrait facilement tomber en raison des vibrations ou du choc des vagues. L'unité doit uniquement être montée sur une surface dure et plate.

⚠ **AVERTISSEMENT ! NE JAMAIS** raccorder une source d'alimentation supérieure à 16 V CC. Ce raccordement pourrait causer un incendie ou détruire l'émetteur-récepteur.

⚠ **AVERTISSEMENT ! NE JAMAIS** inverser la polarité du câble d'alimentation CC lors de la connexion à une source d'alimentation. Cela pourrait endommager l'émetteur-récepteur.

⚠ **AVERTISSEMENT ! NE JAMAIS** retirer le porte-fusible du câble d'alimentation CC. Un courant excessif provoqué par un court-circuit pourrait causer un incendie ou endommager l'émetteur-récepteur.

⚠ **AVERTISSEMENT ! NE JAMAIS** placer jamais l'émetteur-récepteur à un endroit pouvant gêner le fonctionnement normal du navire, ou à un endroit où il pourrait causer des blessures corporelles.

⚠ **AVERTISSEMENT ! NE JAMAIS** laisser de métal, du fil ou d'autres objets dépasser dans l'émetteur-récepteur ou dans les connecteurs sur le panneau arrière. Cela risquerait de provoquer un choc électrique.

ATTENTION : NE PAS utiliser de dissolvants agressifs tels que du benzène ou de l'alcool lors du nettoyage, car ils endommageraient les surfaces de l'émetteur-récepteur.

ATTENTION : NE PAS utiliser ou placer l'émetteur-récepteur dans des zones soumises à des températures hors de la plage de $-20^{\circ}\text{C} \sim +55^{\circ}\text{C}$ ($-4^{\circ}\text{F} \sim +131^{\circ}\text{F}$).

ATTENTION : NE PAS placer l'émetteur-récepteur dans un environnement excessivement poussiéreux ou en plein soleil.

ATTENTION : NE PAS utiliser de microphones autres que Icom. Les microphones des autres fabricants disposent d'affectation de broches différentes, et le raccordement au l'émetteur-récepteur risque d'endommager l'émetteur-récepteur.

ATTENTION : NE PAS placer l'émetteur-récepteur contre un mur ou poser des objets dessus. Il risquerait de surchauffer.

MISE EN GARDE ! L'unité principale de l'émetteur-récepteur chauffe en cas d'utilisation continue sur une longue durée de l'émetteur-récepteur.

MISE EN GARDE ! Le panneau avant de la télécommande est conforme aux exigences IPX7 en matière de protection étanche. Cependant, une fois que l'émetteur-récepteur est tombé, ou que le joint d'étanchéité est fissuré ou endommagé, la protection étanche ne peut pas être garantie en raison des dommages possibles au boîtier ou au joint d'étanchéité.

① Les connecteurs sur le panneau arrière ne sont pas conformes à IPX7.

REMARQUE : L'écran LCD peut avoir des imperfections cosmétiques qui apparaissent sous forme de petites taches sombres ou lumineuses. Il ne s'agit pas un dysfonctionnement ou d'un défaut, mais d'une caractéristique normale des écrans LCD.

REMARQUE : Installez le l'émetteur-récepteur et le microphone à au moins 1 m (3.3 ft) du compas de route du navire.



REMARQUE : Placez toujours l'unité dans un endroit sûr pour éviter que des personnes non autorisées ne l'utilisent par inadvertance.

KEY ICON DESCRIPTION

The keys are described in this manual as follows:



The keys that have words or letters on them are described with the characters “[].”

Example: [ENT], [CLR]



The Software Keys are described with the words or letters on a blue background, such as **Enter**  or **Compose Distress** .

The functions of the keys are shown at the bottom of the display. Push the key below the desired function.

You can use the following keys on the Menu screen.

FUNCTION	ACTION
Select	Push [▲] or [▼].
Enter	Push [ENT], [CH/GRP], or Enter  .
Go to the next tree level	Push [ENT], [CH/GRP], [▶] or Enter  .
Go back to the previous tree level	Push [CLR], [◀], or Back  .
Cancel	Push [CLR].
Exit	Push Exit .

The following action icons describe [CH/GRP], [ENT], the Keypad keys, and [◀], [▶], [▲], and [▼]

- Rotate  : Rotate [CH/GRP] to select.
- Push **ENT** : Push [ENT] to enter or set.
- Push  : Push the Keypad keys to enter a digit or text.
- Push  : Push [◀], [▶], [▲], or [▼] to select.

RECOMMENDATION

CLEAN THE REMOTE CONTROLLER'S FRONT PANEL THOROUGHLY IN A BOWL OF FRESHWATER after exposure to saltwater, and dry it before operating. Otherwise, the remote controller's keys, switches may become unusable, due to salt crystallization.

① The connectors on the rear panel do not meet IPX7.

NOTE: If the remote controller's waterproof protection appears defective, carefully clean it with a soft, damp (freshwater) cloth, then dry it before operating. The remote controller may lose its waterproof protection if the case or connector cover is cracked or broken, or the remote controller has been dropped. Contact your Icom distributor or your dealer for advice.

TABLE OF CONTENTS

IMPORTANT.....	i	Other functions	18	DSC Settings	55
EXPLICIT DEFINITIONS.....	i	Setting a temporary operating		◇ DSC Frequency.....	55
IN CASE OF EMERGENCY.....	i	frequency.....	20	◇ Scanning Receiver.....	56
FEATURES.....	i	Setting a User channel, an ITU		◇ Auto ACK.....	57
RADIO OPERATION WARNING.....	ii	Simplex channel, or an e-mail		◇ CH Auto Switch.....	58
AVERTISSEMENT POUR LES		channel	21	◇ NMEA Data Output.....	58
OPÉRATEURS RADIO.....	ii	Assigning a function.....	22	◇ Alarm Status.....	58
FCC INFORMATION	iii	◇ Assigning a Software Key function		◇ Self Check Test.....	60
INFORMATION FCC	iii	to a Software Key.....	22	◇ Procedure.....	60
PERCAUTIONS.....	iv	◇ Assigning a Software Key function		8 MENU ITEMS.....	61
PRÉCAUTIONS.....	v	to [VOL].....	23	Menu items	61
KEY ICON DESCRIPTION.....	vi	◇ Assigning a Software Key		GPS Information	62
RECOMMENDATION.....	vi	function to [P] on the HM-214H		Configuration	62
1 OPERATING RULES.....	1	MICROPHONE	23	Radio Settings	65
2 PANEL DESCRIPTION.....	2	7 DSC OPERATION.....	24	Radio Information	67
Main unit front panel.....	2	DSC address ID.....	24	9 CONNECTIONS AND	
Main unit rear panel.....	3	◇ Entering an Individual or Group ID		INSTALLATION.....	68
Remote Controller front panel.....	4	24	Supplied accessories.....	68
Optional HM-214M.....	5	◇ Delete an entered ID	25	Connections.....	68
Software Keys.....	5	Entering the position data and time ..	26	◇ Connecting the microphone	68
◇ Selecting a Software Key function..	5	DSC Task mode (Single)	27	◇ Connecting the remote control	
◇ Functions.....	6	◇ Software Key functions	27	cable.....	69
Function display (Main screen).....	7	◇ Unread List.....	27	◇ Front panel connections.....	69
◇ Status area.....	7	DSC Task mode (Multiple).....	28	◇ Rear panel connections	70
◇ Task area.....	7	◇ Software Key functions	28	Ground connection	71
◇ Information area.....	7	◇ Task List	28	Power source.....	71
◇ Channel area.....	7	Sending DSC calls (Distress)	29	Antenna	72
◇ Software Key area.....	8	◇ Simple call.....	29	◇ MN-100/MN-100L ANTENNA	
◇ Position and Time area	8	◇ Regular call	30	MATCHERS.....	72
3 PREPARATION.....	9	◇ Resending a Distress call.....	31	◇ AT-130/AT-120/AH-3 AUTOMATIC	
Entering the MMSI code	9	◇ Distress Cancel call.....	32	ANTENNA TUNER.....	72
4 MENU SCREEN.....	10	◇ Sending a Distress Relay		◇ Non-Icom Tuner	72
Menu Construction.....	10	Acknowledgment.....	34	◇ AT-140 AUTOMATIC ANTENNA	
Selecting the item	11	Sending DSC calls (other).....	35	TUNER.....	72
5 BASIC OPERATION	12	◇ Sending an Individual call	35	Mounting	73
Selecting a channel or Group	12	◇ Sending an Individual		◇ Mounting location	73
◇ Using the channel and group		Acknowledgment.....	36	◇ Mounting the remote controller..	73
selector.....	12	◇ Sending a Group call.....	37	◇ Mounting the Main unit.....	73
◇ Using the Keypad keys	12	◇ Sending a Geographical Area call		MB-75 installation	74
◇ Channel and Channel Group list..	12	39	Transceiver dimensions.....	75
Receiving and transmitting	13	◇ Sending a Test call	42	Fuse replacement.....	76
◇ Receiving	13	◇ Sending a Test call		◇ Circuitry fuse	76
◇ Transmitting.....	13	Acknowledgment.....	43	◇ DC power cable fuses	77
DSC Scan	13	Receiving DSC calls (Distress).....	44	Connector information	78
CW operation.....	14	◇ Receiving a Distress call	44	10 SPECIFICATIONS AND	
◇ Connecting a CW key	14	◇ Receiving a Distress		OPTIONS	80
FSK operation.....	14	Acknowledgment.....	45	11 TROUBLESHOOTING.....	82
◇ Connecting an FSK terminal unit..	14	◇ Receiving a Distress Cancel call ..	45	TEMPLATE	83
e-mail operation.....	15	◇ Receiving a Distress Relay call..	46	INDEX.....	85
◇ Operation	15	◇ Receiving a Distress Relay			
◇ e-mail Filter	15	Acknowledgment.....	47		
6 OTHER FUNCTIONS AND		Receiving DSC calls (other).....	48		
OPERATIONS.....	16	◇ Receiving an Individual call.....	48		
Backlight function.....	16	◇ Receiving an Individual			
Scan.....	16	Acknowledgment.....	49		
◇ CH and CH Resume	16	◇ Receiving a Group call	50		
◇ Program	17	◇ Receiving a Geographical Area			
Using the Voice Recorder.....	17	call.....	51		
◇ Playback the recorded voice.....	17	◇ Receiving a Test call	52		
		◇ Receiving a Test Acknowledgment			
		53		
		DSC Log	54		
		◇ Received DSC Log.....	54		
		◇ Transmitted DSC Log.....	54		

NOTE: Before transmitting, monitor the channel you want to use to avoid interrupting communications already in progress.

● CALL PROCEDURE

Calls must be properly identified and the time limit must be respected.

1. Give your call sign each time you call another ship or Coast Guard station. If you have no call sign, identify the station by giving your ship name and the name of the licensee.
2. Give your call sign at the end of each transmission that lasts more than 3 minutes.
3. You must break and give your call sign at least once every 15 minutes during long ship-to-shore calls.
4. Keep your unanswered calls short, less than 30 seconds. Do not repeat a call for 2 minutes.
5. Unnecessary transmissions are not allowed.

● PRIORITIES

1. Read all rules and regulations pertaining to priorities and keep an up-to-date copy handy. Safety and Distress calls take priority over any other calls.
2. False or fraudulent Distress signals are prohibited and punishable by law.

● PRIVACY

1. Information overheard, but not intended for you, cannot lawfully be used in any case.
2. Indecent or profane language is prohibited.

● LOGS

1. All Distress, Emergency and Safety calls must be recorded in complete details. Log data activity is usually recorded for 24 hours. Universal Time Coordinated (UTC) is frequently used.
2. Keep adjustments, repairs, channel frequency changes and authorized modifications affecting electrical operation of the equipment in the maintenance log. The entries requires signatures by the authorized licensed technician performing or supervising the work.

● RADIO LICENSES

(1) SHIP RADIO STATION LICENSE

You need a current ship radio station license before using the transceiver. It is unlawful to operate a ship radio station which is not licensed, but required to be.

If required, contact your dealer or the appropriate government agency for a Ship-Radiotelephone license application. This government-issued license states the call sign which is your craft's identification for radio communication purposes.

(2) OPERATOR'S LICENSE

A Restricted Radiotelephone Operator Permit is the license most often held by small vessel radio operators when a radio is not required for safety purposes.

If required, the Restricted Radiotelephone Operator Permit must be posted, or kept with the operator. If required, only a licensed radio operator may operate a transceiver.

However, non-licensed individuals may talk over a transceiver if a licensed operator starts, supervises, ends the call, and makes the necessary log entries.

A current copy of the applicable government rules and regulations is only required to be on hand for vessels in which a radio telephone is compulsory. However, even if you are not required to have these on hand it is your responsibility to be thoroughly acquainted with all pertinent rules and regulations.

■ Main unit front panel

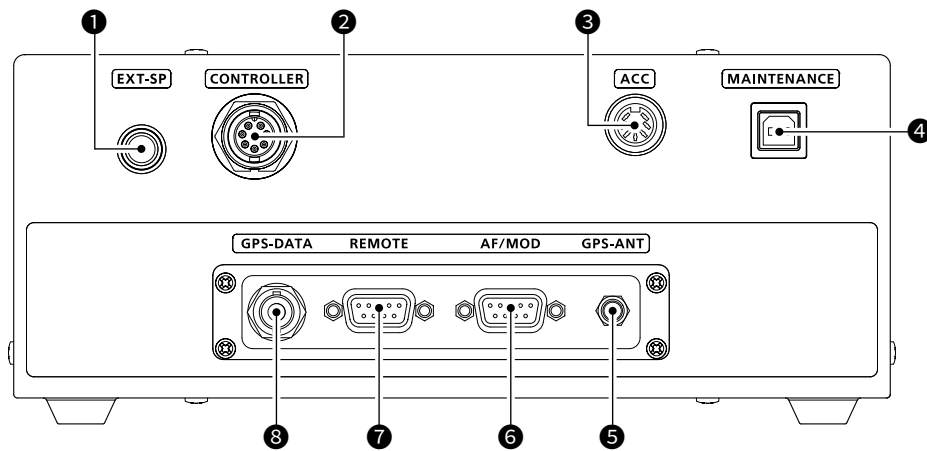

❶ SPEAKER JACK [EXT-SP] (p. 69)

Connects to the optional SP-24 or an external speaker.

NOTE: When an external speaker is connected, the internal speaker is automatically muted.

❷ CONTROLLER CONNECTOR [CONTROLLER] (p. 69)

Connects to the supplied remote controller.

❸ ACCESSORY CONNECTOR [ACC] (pp. 14, 78)

Connects to a CW keyer or an FSK terminal unit.

❹ MAINTENANCE PORT [MAINTENANCE]

Connects to a USB cable for programming the transceiver.

① This connector is only used by your dealer.

❺ GPS ANTENNA CONNECTOR [GPS-ANT] (p. 69)

Connects to the supplied GPS antenna.

NOTE: Install the GPS antenna where it has a clear view to receive signals from satellites.

❻ MODEM CONNECTOR [AF/MOD] (pp. 69, 79)

Connects to an e-mail modem, NBDP (Narrow Band Direct Printing) or FAX system through an RS-232C cable (D-sub 9-pin).

❼ REMOTE CONNECTOR [REMOTE] (pp. 69, 79)

Connects to a PC through an RS-232C cable (D-sub 9-pin) for remote control.

❽ GPS JACK [GPS-DATA] (pp. 69, 79)

Connects to a GPS receiver to input position and UTC data for DSC operations. (NMEA0183 ver. 4.10 format)

① An NMEA ver. 4.10 (sentence formatter: GGA, GLL, GNS, RMC, VTG) compatible GPS receiver is required. Ask your dealer about suitable GPS receivers.

■ Main unit rear panel

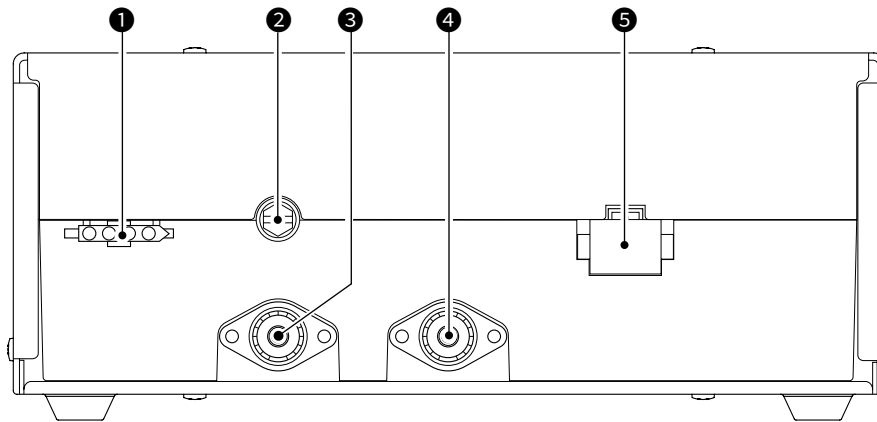

❶ TUNER CONTROL SOCKET (pp. 70, 71, 78)

Connects to the control cable of the supplied AT-140 HF AUTOMATIC ANTENNA TUNER. A female connector kit is supplied to connect the AT-140.

❷ GROUND TERMINAL (p. 71)

Connects to the vessel's ground.

❸ ANTENNA CONNECTOR (p. 70, 71)

Connects to a dipole antenna, or an automatic antenna tuner through a 50 Ω PL-259 coax for transmitting any calls and receiving any calls, other than Distress calls.

⚠ WARNING! NEVER connect the antenna directly to this connector.

❹ DSC ANTENNA CONNECTOR (p. 70, 71)

Connects to a 50 Ω HF marine band antenna through a 50 Ω PL-259 coax for a DSC receiver. This antenna is used for receiving Distress calls.

NOTE: To receive a Distress call, **BE SURE** to connect an HF marine band antenna to this antenna connector. Otherwise, you cannot receive any Distress calls.

❺ DC POWER SOCKET (p. 70, 78)

Connects to 13.6 V DC through the supplied DC power cable.

Remote Controller front panel

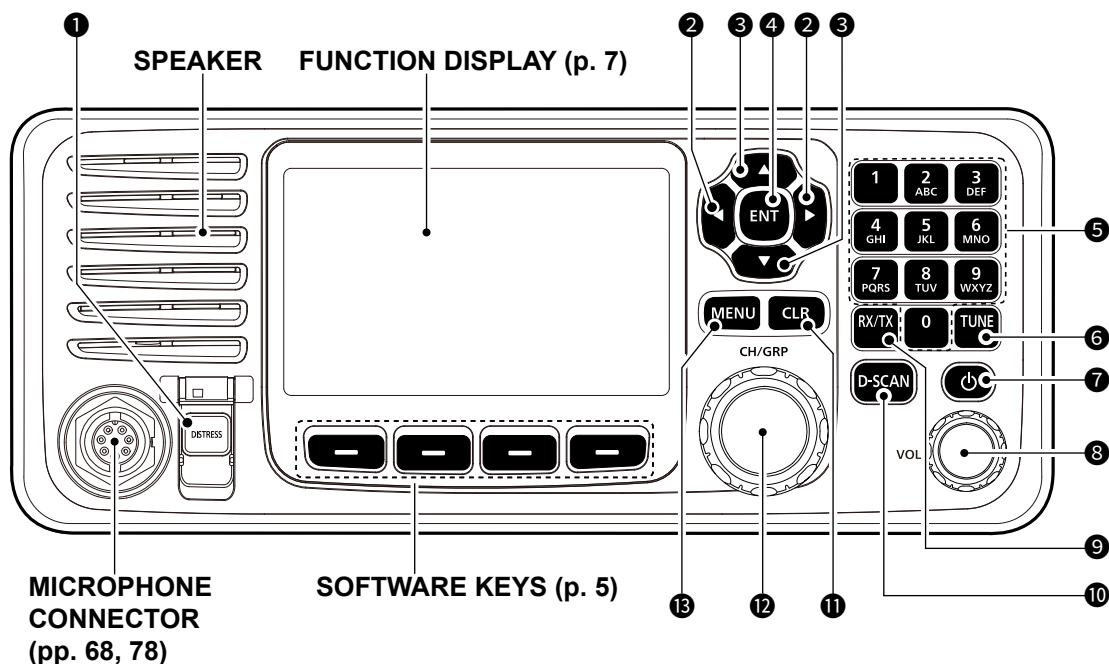

1 DISTRESS KEY [DISTRESS]

Hold down for 3 seconds to transmit a Distress call. (p. 29)

2 LEFT AND RIGHT KEYS [◀]/[▶]

- Push to scroll the Software Key functions. (p. 5)
- In the Character or Number Entry mode, push to select a character or number in the table.

3 UP AND DOWN KEYS [▲]/[▼]

- Push to select an operating channel, menu items, menu settings, and so on.

4 ENTER KEY [ENT]

Push to set the entered data, selected item, and so on.

5 KEYPAD KEYS

Push to enter numbers, letters, or symbols.

6 TUNE KEY [TUNE]

When the AT-140 or AH-3 is connected:

- Push to start manual tuning, or to bypass the tuning circuit.
- Hold down to start manual tuning.
 - ① "TUNE" is displayed after tuning is completed.
 - ① "THRU" is displayed when the tuner cannot tune the antenna.

When an other antenna tuner is connected:

- Push to start manual tuning.

7 POWER KEY [⏻]

Hold down for 1 second to turn the transceiver ON or OFF.

8 VOLUME DIAL [VOL]

- Rotate to adjust the speaker volume level.
- Push 1 ~ 5 times to display the setting screens.

Pushing once	The Volume Setting window is displayed.
Pushing twice	The NB Level Setting window is displayed.
Pushing 3 times	The S-SQL Level Setting window is displayed.
Pushing 4 times	The RF Gain Setting window is displayed.
Pushing 5 times	The Backlight Settings window is displayed.

9 RX/TX KEY [RX/TX]

Push to set a temporary operating frequency. (p. 20)

10 DSC SCAN KEY [D-SCAN]

Push to start a DSC scan. (p. 13)

11 CLEAR KEY [CLR]

Push to cancel the entered data, or to return to the previous screen.

12 CHANNEL/GROUP SELECTOR [CH/GRP]

- Push to select the Channel Select mode or the Group Select mode. (p. 12)
- Push to set the entered data, selected item, and so on.
- Rotate to select the operating channel, menu items, menu settings, and so on.

13 MENU KEY [MENU]

Push to enter or exit the Menu screen.

■ Optional HM-214M

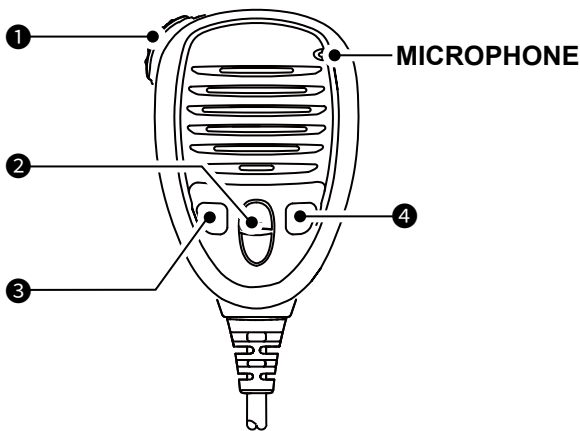

- 1 PTT SWITCH**
Hold down to transmit, release to receive.
- 2 UP/DOWN KEYS [▲]/[▼]**
Push to select an operating channel or group.
- 3 PROGRAMMABLE KEY [P]**
Push to activate the preset Software Key function. Ask your dealer for details.
 - ① You can reassign some Software Key functions to the key. (p. 23)
- 4 DSC SCAN KEY [D-SCAN]**
Push to start the DSC scan. (p. 13)

■ Software Keys

Various often-used functions are assigned to the Software Keys for easy access. The function's icons are displayed above the Software Keys, as shown below.

◇ Selecting a Software Key function

Push [◀] or [▶] to slide through the selectable functions that are assigned to the Software Keys. Push the Software Key under the function's icon to select the function.

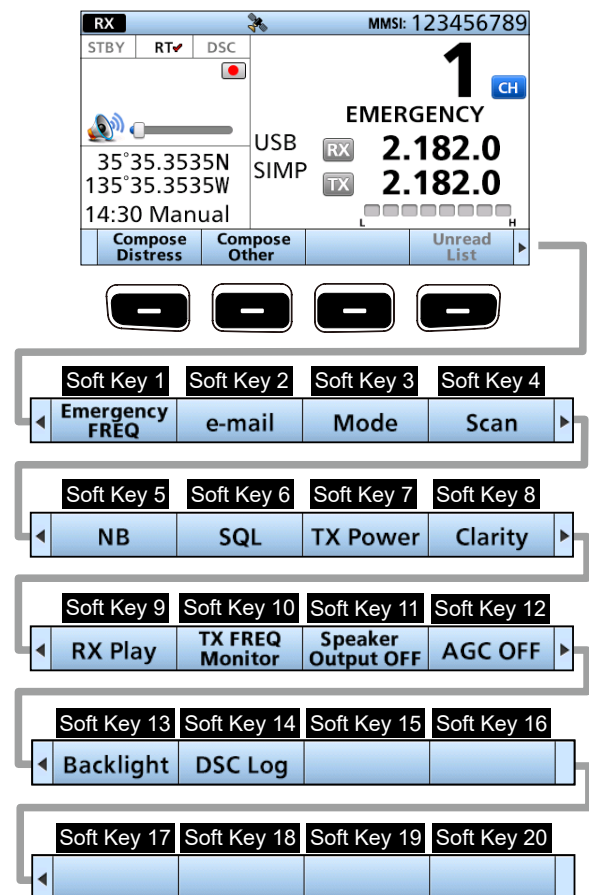

① The key function may differ, depending on the transceiver version or presetting.

2 PANEL DESCRIPTION

■ Software key function

◇ Functions

You can use various Software Key functions that are assigned to the Software Keys, as described below.

Compose Distress

Push to compose a Distress call. (pp. 29 ~ 34)

Compose Other

Push to compose DSC calls other than Distress calls. (pp. 35 ~ 43)

Unread List

Push to check unread DSC messages. (p. 27)

Task List

Push to check the held DSC tasks. (p. 28)

Emergency FREQ

Push to use the Distress Voice frequency. (p. 18)

e-mail

Push to use the e-mail channel. (p. 15)

e-mail Filter

Push to temporarily change the filter setting of the e-mail channel. (p.15)

Mode

Push to select the USB, AM, LSB, AFSK, FSK, or CW operating mode.

Scan

Push to start or stop a scan. (pp. 16 ~ 17)

NB

Push to turn the Noise Blanker (NB) function ON or OFF. (p. 18)

NB Level

Push to adjust the Noise Blanker (NB) level. (p. 18)

SQL

Push to turn the Squelch function ON or OFF. (p. 18)

S-SQL Level

Push to adjust the S-meter Squelch (S-SQL) level. (p. 18)

RF Gain

Push to adjust the Radio Frequency (RF) gain level. (p. 18)

TX power

Push to select the transmit (TX) power level. (p. 18)

Clarity

Push to turn the Clarity Control function ON or OFF. (p. 19)

Voice Scrambler

Push to turn the Voice Scrambler function ON or OFF. (p. 19)

RX Play

Push to replay the recorded audio data. (p. 17)

TX FREQ Monitor

Push to check and monitor the transmit frequency. (p. 19)

Speaker Output OFF

Push to turn the speaker output ON or OFF. (p. 19)

AGC OFF

Push to turn the Automatic Gain Control (AGC) function ON or OFF. (p. 19)

Backlight

Push to change the brightness of the backlight. (p. 16)

DSC Log

Push to check the received DSC calls. (p. 54)

TIP: You can reassign the function's place to meet your needs between Soft Key 1 and Soft Key 20. See page 22 for details.

- ① The first set of Software Key functions ([Compose Distress], [Compose Other] and [Unread List]) are fixed and cannot be reassigned.
- ① When the MMSI code is not set, the Software Keys for DSC function are not displayed.

■ Function display (Main screen)

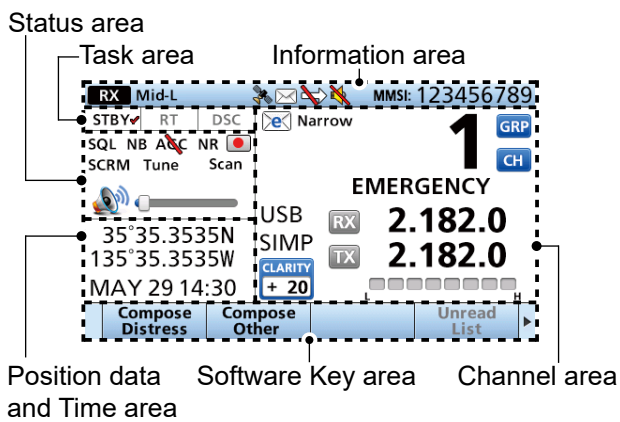

◇ Status area

The current status is displayed in the Status area.

Indicator	Description
SQL	Displayed when the Squelch function is ON.
NB	Displayed when the Noise Blanker function is ON.
AGC	Displayed when the AGC function is OFF.
NR	Displayed when the Noise Reduction function is ON.
	• Displayed when the received audio is recorded. (p. 17)
	• Displayed when recording the received audio is stopped. (p. 17)
SCRM	Displayed when the Voice Scrambler function is ON.
Tune	Displayed when the Tune function is ON.
Scan	Displayed during a scan.
	• Displayed when the volume is set to 1 to 20.
	• Displayed when the volume is set to 0.

◇ Task area

The current mode is displayed in the Task area.

Indicator	Description
STBY	Displayed while in the Standby mode.
RT	Displayed while in the Radio Telephone (RT) mode. ① Returns to the Standby mode if no operation occurs during the preset of time.
DSC/ DSC (1)	Displayed after making or receiving a DSC call. ① If the transceiver is in the Multiple Task mode, the number of the DSC task is displayed by the indicator.

◇ Information area

The 9 digit MMSI (Maritime Mobile Service Identity: DSC self ID) code and the following indicators are displayed in the information area.

Indicator	Description
	Displayed when receiving a signal, or when the squelch is open.
	Displayed while transmitting.
Low/ Mid-L/ Mid-H	<ul style="list-style-type: none"> • Displayed when the TX power is set to each level. • If no indicator is displayed, the TX power is set to "High."
	<ul style="list-style-type: none"> • Displayed when the GPS receiver is activated, and valid position data is received. • Blinks while invalid position data is being received.
	<ul style="list-style-type: none"> • Displayed when there is an unread DSC message. • Blinks when there is a new DSC message.
	Displayed when the "CH Auto Switch" in DSC setting is set to an option except "Accept after 10 sec."
	Displayed when the internal speaker is OFF.

◇ Channel area

The selected operating channel number, channel name, and the following indicators are displayed in the Channel area.

Indicator	Description
	Displayed when the Channel Select mode is selected.
	Displayed when the Group Select mode is selected.
	Displayed when the Clarity function is ON. The number displays the added or subtracted frequency.
	Displayed when the e-mail channel is selected.
	① The Filter setting is also displayed.
Emergency	Displayed when the Emergency FREQ channel is selected.
	<ul style="list-style-type: none"> • When receiving, the S meter displays the relative signal strength. • When transmitting, the RF meter displays the output power level.
SIMP	Displayed when a Simplex channel is selected.
DUP	Displayed when a Duplex channel is selected.
USB/ AM/LSB/ AFSK/ FSK/CW	Displays the selected operating mode.

2 PANEL DESCRIPTION

■ Function display

◇ Software Key area

The Key function for each Software Key is displayed. See page 5 for details.

◇ Position and Time area

Position area

The current position is displayed when valid GPS data is received, or when you manually enter your position.

Indicator	Description
No Position	Displayed when a GPS receiver is not connected, and the position data has not been manually entered.
??	Blinks every 2 seconds instead of the position when the GPS position data is invalid. ① The last position is held for only 23.5 hours. After that, "No Position" will be displayed.
	Blinks every 2 seconds instead of the position after 4 hours have passed since you manually entered the position data. ① The manually entered data is held for only 23.5 hours. After that, "No Position" will be displayed.

Date and Time area

- The current time is displayed when valid GPS data is received, the time is manually entered.
- The date information is displayed when the RMC GPS sentence formats are included in the GPS signal.

Indicator	Description
No Time	Displayed when a GPS receiver is not connected and the time has not been manually entered.
Local	Displayed when the offset time is set.
Manual	Displayed when the time is manually entered.
??	Blinks every 2 seconds instead of the time when the GPS current time is invalid. ① After 23.5 hours has passed, "No Time" will be displayed.
	Blinks every 2 seconds instead of the time after 4 hours have passed since you manually entered the time. ① The manually entered time is held for only 23.5 hours. After that, "No Time" will be displayed.

■ Entering the MMSI code

The Maritime Mobile Service Identity (MMSI: DSC self ID) code consists of 9 digits. You can only enter the code when turning ON the transceiver for the first time.

This initial code can be entered only once. After entering, it can be changed only by your dealer or distributor. If your MMSI code has already been entered, doing the steps below is not necessary.

1. Hold down [⏻] to turn ON the transceiver.
 - Three short beeps sound, and then “Push [ENT] to Register your MMSI” is displayed.

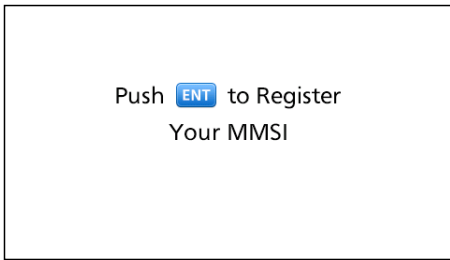

2. Push [ENT] to start entering the MMSI code.
 - The “MMSI” screen is displayed.
 - ① To skip the entry, push [CLR] twice. If you skip the entry, you cannot make a DSC call. To enter the code after skipping, turn OFF the power, and then turn it ON again.

3. Enter the MMSI code.

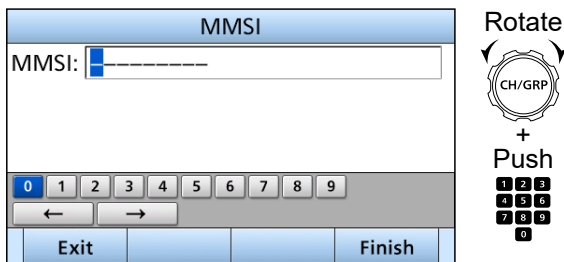

4. Repeat step 3 to enter all 9 digits.
5. Push the software key below [Finish] to set the entered code.

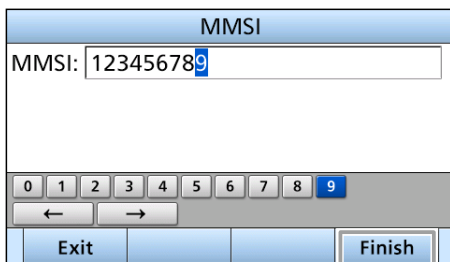

- The “MMSI CONFIRMATION” screen is displayed.

6. Enter your MMSI code again to confirm.

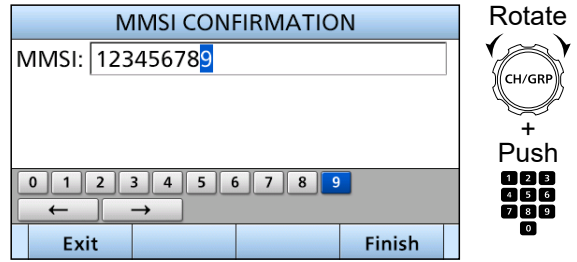

7. Push [Finish] to set the confirmation code.



- When your MMSI code is successfully entered, “MMSI Successfully Registered” is briefly displayed, and then the Main screen opens.
- ① Your MMSI code is also displayed on the opening screen.

2
3

4

MENU SCREEN

The Menu screen is used to set items, select options, and so on for the transceiver's functions.

Menu Construction

The Menu screen is constructed in a tree structure. You can go to the next tree level by pushing [ENT], or [▶], and go back a level by pushing [CLR], or [◀]. See the next page for details.

① The displayed menu items may differ, depending on the transceiver version or presetting.

To select an item, rotate [CH/GRP], or push [▲] and [▼].

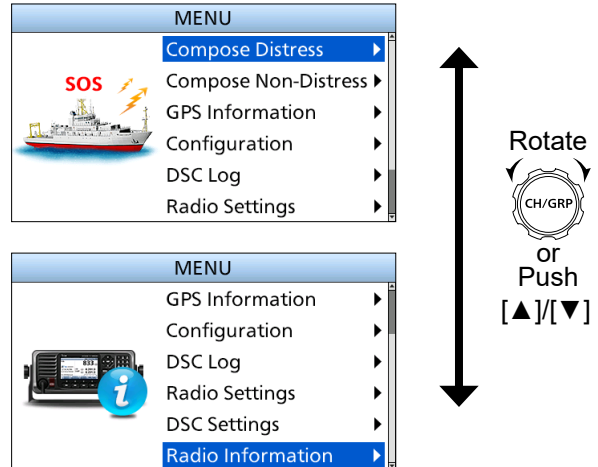

Compose Distress
Nature of Distress
Position
• Latitude
• Longitude
• UTC
Mode
Attempt

Compose Non-Distress
Message Type
Address
Area
• Latitude
• Longitude
• Radius
• Height
• Width
Category
Call Frequency
• RX Frequency
• TX Frequency
Mode
Voice Frequency
• RX Frequency
• TX Frequency

GPS Information
Source
Latitude
Longitude
UTC
SOG
COG

Configuration
Display
• Backlight
• Day Mode
• Night Mode
• Mode
• Night Mode Time
• Start
• End
Key Beep
Key Assignment
• Softkey Assignment
• Volume Dial Assignment
• P Key Assignment
MIC Key Lock
UTC Offset
Inactivity Timer
• Not DSC Related
• DSC Related
• RT Related: USB/AM/LSB/AFSK/ FSK/CW/e-mail
GPS
• Internal GPS
• GPS
• GLONASS
• SBAS
• External GPS
• Baud Rate
• NMEA Data Output
Remote
• Interface
• MOD
• Baud Rate

DSC Log
Received Call Log
• Distress
• Others
Transmitted Call Log

Radio Settings
User CH
MAX User CH
e-mail CH
ITU Simplex CH
Auto Tune
External Tuner
Noise Reduction
Scan
• Type
• Speed
• Program Scan FREQ
• Start Frequency
• End Frequency
Voice Scrambler Code
Voice SQL
IF Filter
• AFSK Filter
• FSK Filter
FSK
• ITU FSK CH
• Mark Frequency
• Shift Frequency
• Polarity
CW break-in
Instant Replay
• Function
• Recording Time
• Play Time

DSC Setting
Position Input
Individual ID
Group ID
DSC Frequency
Scanning Receiver
• Distress
• Routine
Auto ACK
• Individual ACK
• Test ACK
CH Auto Switch
NMEA Data Output
Alarm Status
• Safety/Routine/ Warning/Self- Terminate/Discrete/ MAX Distance 2-Tone
Self Check Test
Procedure

Radio Information
MMSI
Serial No.
Main
Sub
FPGA
GPS

■ Selecting the item

Follow the procedures described below to select a Menu screen.

Example: Turning ON the Voice Squelch function.

1. Open "Voice SQL."

[MENU] > Radio Settings > **Voice SQL**

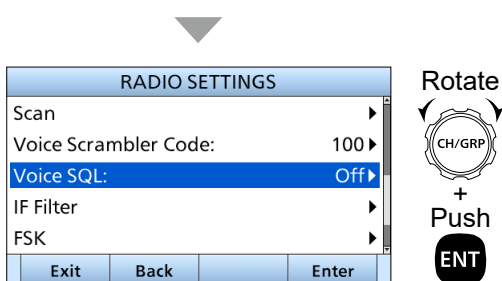
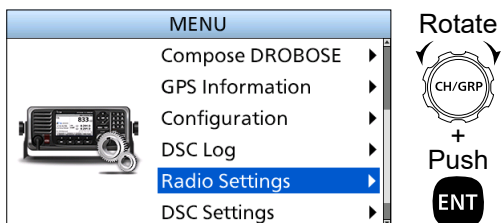

2. Select "On."

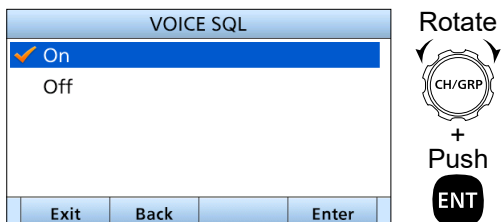

- Returns to the Radio Settings screen.

3. Push [MENU], or **Exit**  to return to the Main screen.

■ Selecting a channel or Group

◇ Using the channel and group selector

1. Push [CH/GRP] to toggle between the Channel Select mode and the Group Select mode.
 - **CH** or **GRP** is displayed.
2. Rotate [CH/GRP] to select a channel or group.
 - ① When selecting the Group Select mode, the User channels change in 20 channel steps.

NOTE: See the Channel and Channel Group list below.

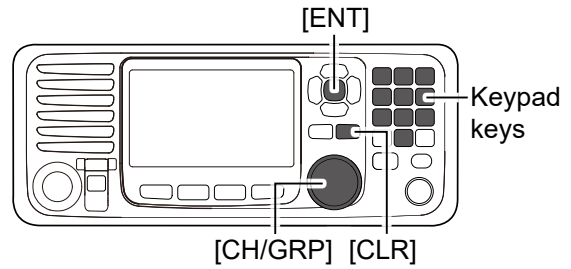

- Channel Select mode
- Group Select mode

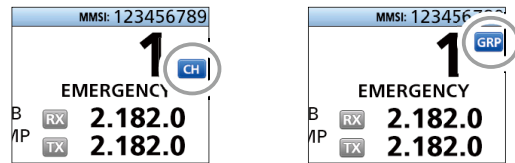

◇ Using the Keypad keys

- When selecting a User channel, an ITU duplex channel, or an ITU FSK channel

1. Push the Keypad keys to enter the channel number.
2. Push [ENT] to set.

Example:

Selecting CH 1: [1] → [ENT]
 Selecting CH 41: [4] → [1] → [ENT]
 Selecting CH 101: [1] → [0] → [1] → [ENT]
 Selecting CH 1815: [1] → [8] → [1] → [5] → [ENT]
 Selecting CH 22026: [2] → [2] → [0] → [2] → [6] → [ENT]

NOTE:

- See the Channel and Channel Group list below.
- Pushing [CLR] clears the entered digits and returns to the previous channel.

- When selecting an ITU simplex channel

1. Push the Keypad keys to select a frequency band.
2. Push the left most Software Key to enter a “-” (dash).
3. Push the Keypad keys to enter the channel number.

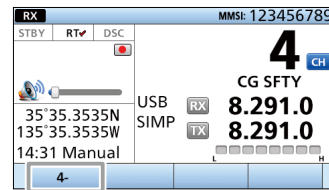

4. Push [ENT] to set.

Example:

Selecting CH 4-1: [4] → [4-] → [1] → [ENT]
 Selecting CH 25-9: [2] → [5] → [25-] → [9] → [ENT]

◇ Channel and Channel Group list

Channel No.	Description
1 ~ 160	User CH
401 ~ 429	4 MHz ITU duplex CH
4-1 ~ 4-9	4 MHz ITU simplex CH
601 ~ 608	6 MHz ITU duplex CH
6-1 ~ 6-9	6 MHz ITU simplex CH
801 ~ 837	8 MHz ITU duplex CH
8-1 ~ 8-9	8 MHz ITU simplex CH
1201 ~ 1241	12 MHz ITU duplex CH
12-1 ~ 12-9	12 MHz ITU simplex CH
1601 ~ 1656	16 MHz ITU duplex CH
16-1 ~ 16-9	16 MHz ITU simplex CH
1801 ~ 1815	18 MHz ITU duplex CH
18-1 ~ 18-9	18 MHz ITU simplex CH
2201 ~ 2253	22 MHz ITU duplex CH
22-1 ~ 22-9	22 MHz ITU simplex CH

Channel No.	Description
2501 ~ 2510	25 MHz ITU duplex CH
25-1 ~ 25-9	25 MHz ITU simplex CH
C1-1 ~ C1-21	C1 channels
C2-1 ~ C2-31	C2 channels
4001 ~ 4013	4 MHz ITU FSK CH
6001 ~ 6014	6 MHz ITU FSK CH
8001 ~ 8015	8 MHz ITU FSK CH
12001 ~ 12092	12 MHz ITU FSK CH
16001 ~ 16031	16 MHz ITU FSK CH
18007 ~ 18020	18 MHz ITU FSK CH
22013 ~ 22026	22 MHz ITU FSK CH

- ① When selecting the Group Select mode, the User channels change in 20 channel steps.

■ Receiving and transmitting

◇ Receiving

1. Select a channel by rotating [CH/GRP], or pushing the Keypad keys. (p. 12)
2. When receiving a call, rotate [VOL] to adjust the audio output level.

TIP:

When a call is received:

- **RX** is displayed.
- You can hear received audio from the speaker.
- The S-meter displays the received signal strength.

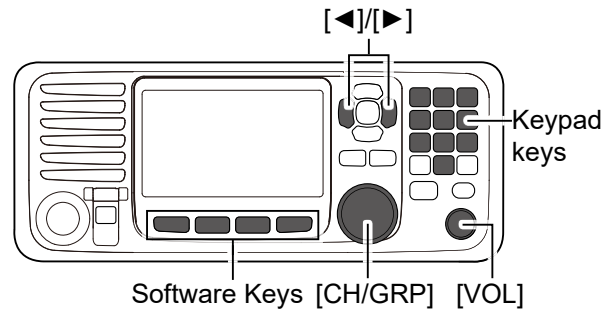

◇ Transmitting

1. Select a channel by rotating [CH/GRP] or pushing the Keypad keys. (p. 12)
2. Push [◀] or [▶] until **TX FREQ Monitor** is displayed in the Software Key area.
3. Hold down **TX FREQ Monitor** to temporarily monitor the transmit frequency of the selected channel.
 - **TX** blinks while holding down.

NOTE: If the channel is busy, wait until it becomes clear, or change to another channel.

4. Hold down [PTT] on the handset and speak into the microphone at your normal voice level.
 - **TX** is displayed while transmitting.

NOTE: If "SWR" is displayed during the transmission, check your antenna system.

5. Release [PTT] to receive.
 - **RX** is displayed.

NOTE: The Time-out Timer function cuts OFF transmission after 16 minutes of continuously transmitting.

TIP: To maximize the readability of your transmitted signal, pause for a second after holding down [PTT]. Hold the microphone 5 to 10 cm (2 to 4 inches) from your mouth, and then speak at your normal voice level.

■ DSC Scan

To receive a DSC call, such as an Individual call or a Group call, push [D-SCAN] to enter the DSC watch mode.

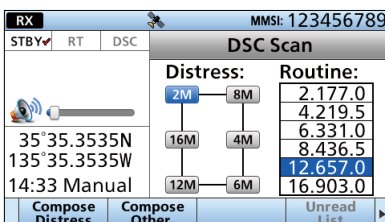

DSC watch mode

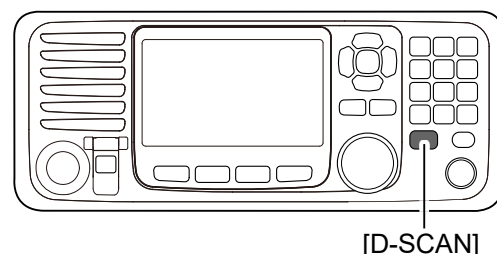

NOTE: The following frequencies are always automatically monitored with this transceiver.

2187.5, 4207.5, 6312.0, 8414.5, 12577.0, and 16804.5 kHz

① The setting for monitoring these frequencies can be changed in the Scanning Receiver setting. (p. 56)

■ CW operation

The transceiver has the following CW keying features selectable in the Set mode, as described on page 67.

- Full: Immediately returns to receive when you release the key.
- Delay: Returns to receive after 0.5 seconds has passed after you stop keying.
- OFF: Manual transmission with the microphone's [PTT] switch, or grounding the SEND line of the [ACC] connector is necessary before keying.

◇ Connecting a CW key

1. Connect a CW key or an external electric keyer to the [ACC] socket, as shown to the right.
2. Select the desired channel to operate in the CW mode.
3. Push [◀] or [▶] until **Mode** is displayed in the Software Key area.
4. Push **Mode**  several times to select "CW."
5. Operate the CW key to transmit a CW signal.

CW key connection

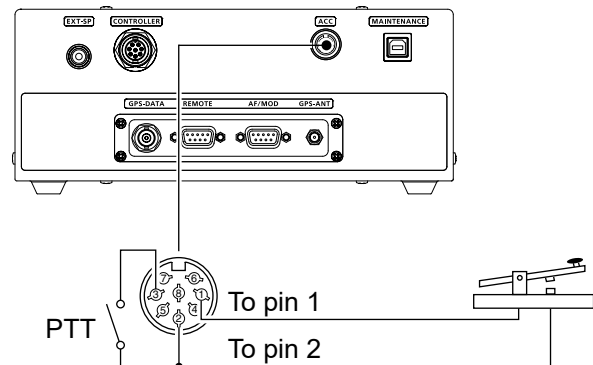

- ① Manual transmission switch for when "OFF" is selected in the "CW break-in" setting. (p. 67)

■ FSK operation

The transceiver has FSK and AFSK modes for FSK operation. Select "FSK" when using the built-in oscillator, and select "AFSK" when using an AFSK terminal unit.

◇ Connecting an FSK terminal unit

1. Connect an FSK terminal unit to the [ACC] socket, as shown to the right.
2. Select the desired channel to operate in the FSK mode.
 - ① ITU FSK channel group, Ch 4001 to Ch 22026, are usable only when the "ITU FSK CH" setting is set to "ON." (p. 66)
3. Push [◀] or [▶] until **Mode** is displayed in the Software Key area.
4. Push **Mode**  several times to select "FSK" or "AFSK."
5. Operate using the FSK terminal unit.

FSK terminal unit connection

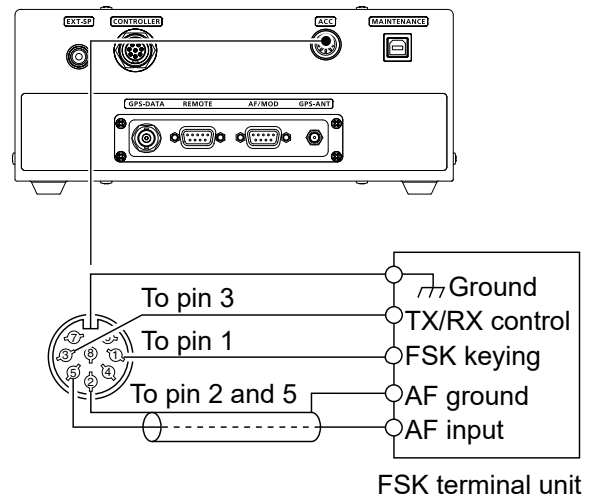

■ e-mail operation

The IC-M803 is ready for HF e-mail operation— up to 160 e-mail frequency channels, and a connection terminal for an e-mail modem are available. Independent e-mail frequencies with operating mode and filter settings can be selected with a push of a button, or group/channel selector rotation, for simple operation.

◇ Operation

1. Connect your PC through an e-mail modem to [AF/MOD] on the IC-M803 main unit front panel.
 - ① See page 69 for connection details.
2. Start up the e-mail application.
 - ① First, set up the necessary information given from your provider for e-mail operation.
3. Push [◀] or [▶] until **e-mail** is displayed in the Software Key area.
4. Push **e-mail** then rotate [CH/GRP], or push [▲] or [▼] to select the desired e-mail channel.

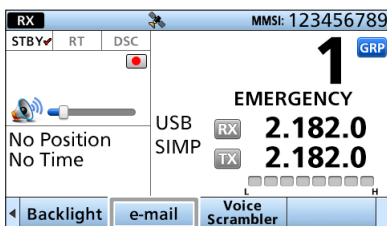

- ① [GRP] changes in 20 channel steps.
 - ① Selectable e-mail frequencies may differ, depending on your provider.
5. Follow the e-mail application instructions for operation.

◇ e-mail Filter

When an e-mail CH is selected, the filter type of the selected channel can be changed to Wide, Middle, or Narrow.

1. Push [◀] or [▶] until **e-mail Filter** is displayed in the Software Key area.
2. Push **e-mail Filter**.
 - The filter width of the selected e-mail channel is changed.

NOTE:

- For e-mail operation, you MUST make a contract with an HF e-mail provider and purchase an e-mail modem from the provider, or your dealer. E-mail frequencies may need to be set by your dealer, depending on your modem selection. Ask your dealer for details.
- When a PC is connected, the remote controller is inhibited and the screen as shown below is displayed. Push **PC Mode Off** to resume operation with the remote controller.

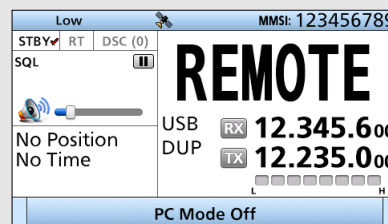

- When an e-mail CH is selected, the Voice scrambler function cannot be turned ON.

■ Backlight function

The function display and keys can be backlit for better visibility under low light conditions.

You can set the Backlight mode to Day mode or Night mode. The Day mode is for the daytime operation, and the screen items are in color. The Night mode is for nighttime operation, and the screen items are displayed in black and red.

1. Push [◀] or [▶] until **Backlight** is displayed in the Software Key area.
2. Push **Backlight**  to open the Backlight setting window.

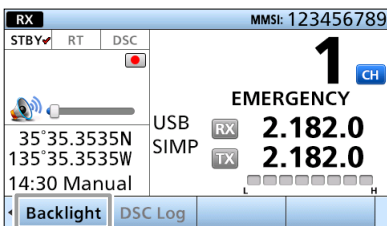

3. Push [▲] or [▼] to select "Day Mode," "Night Mode," or "Auto."
 - ① In the Backlight Setting window, if you push no key for about 5 seconds, the transceiver automatically returns to the Main screen.

Day mode

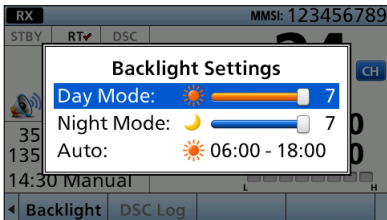

Night mode

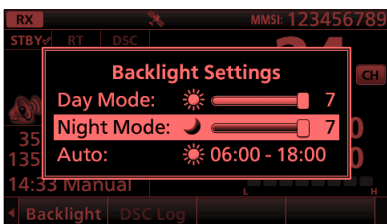

Auto

The Day mode or the Night mode is automatically selected.

4. Adjust the Backlight level.

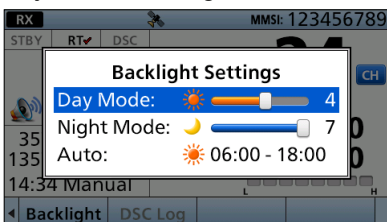

- ① The Backlight level is adjustable in 7 levels and "OFF." "OFF" is selectable only in the Day mode.

■ Scan

The transceiver has automatic channel and frequency scan capabilities (Scan function). There are 3 types of scan functions.

- CH (Channel)
- CH Resume
- Program

◇ CH and CH Resume

The CH and CH Resume searches within a 20 channel range, such as channel 1 to channel 20, in the user channels, and searches all channels in the same bandwidth in the group of ITU channels and ITU FSK channels.

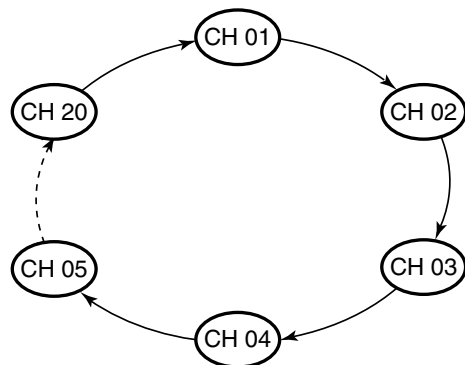

CH:

When [PTT] is pushed, the scan stops and transmission starts on the displayed channel. Even though the squelch is open, the channels are switched at the time set in "Speed" on the Menu screen. (p. 65)



[MENU] > Radio Settings > Scan > **Speed**

CH Resume:

When [PTT] is pushed, transmission starts on the displayed channel while keeping the scan status. When 30 seconds have passed since the transmission stops, scanning is resumed. While the squelch is open, the channels are switched every 10 seconds.

To use the CH scan or CH Resume scan, select "CH" or "CH Resume" on the Menu screen. (p. 65)

[MENU] > Radio Settings > Scan > **Type**

1. Rotate [GRP/CH] to select a channel group. (p. 12)
2. Push [◀] or [▶] until **Scan** is displayed in the Software Key area.
3. Push **Scan**  to start a scan.
4. Push **Scan**  again to stop the scan.

◇ Program

The Program scan searches the selected channel within the frequency range set by the “Start frequency” setting and the “End frequency” setting. (p. 66)

[MENU] > Radio Settings > Scan > Program Scan FREQ > **Start Frequency**

[MENU] > Radio Settings > Scan > Program Scan FREQ > **End Frequency**

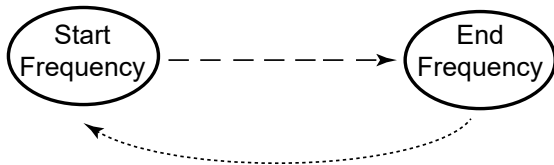

To use the Program scan, select “Program” on the Menu screen. (p. 65)

[MENU] > Radio Settings > Scan > **Type**

1. Rotate [GRP/CH] to select a channel. (p. 12)
2. Push [◀] or [▶] until **SQL** is displayed in the Software Key area.
3. Push **SQL** to turn OFF the Squelch function.
4. Push [◀] or [▶] until **Scan** is displayed in the Software Key area.
5. Push **Scan** to start a scan.
6. Push **Scan** again to stop the scan.

■ Using the Voice Recorder

The transceiver has an automatic recording function that can record the last 120 seconds of the receiving audio. You can playback the audio that you could not hear clearly.

- Starts recording automatically when the signal is received.

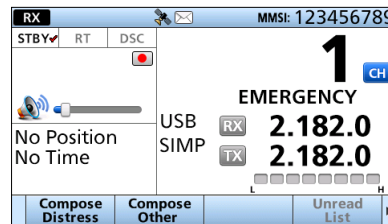

- is displayed when recording the received audio.
- Stops recording 3 seconds after the signal disappears, or when the channel is changed.
- is displayed when recording is stopped.
- The recorded voice data is erased when the transceiver is turned OFF.

◇ Playback the recorded voice

You can set the play start point in “Play Time” setting before playing. (p. 67)

1. Push [◀] or [▶] until **RX Play** is displayed in the Software Key area.
2. Push **RX Play** to play the recorded audio.
 - Playing the recorded audio is automatically started.
 - The play window is displayed as shown below.



TIP:

- To stop playing the recorded audio, push [CH/GRP].
 - ① Push [CH/GRP] again to restart playing.
- Rotate [CH/GRP] to adjust the play start point.
 - ① Set between -2'00 to 0'00.
- Rotate [VOL] to adjust the volume level.
 - ① Set to between 0 (Off) and 20.
- is displayed when playing the recorded audio.
- is displayed when playing the recorded audio is stopped.
- When the play window is displayed, recording the received audio is stopped.

Other functions

Emergency FREQ channel

Select the Distress Voice Frequency. When this channel is selected, the Voice Frequency of a DSC call can be monitored without receiving or transmitting a DSC call.

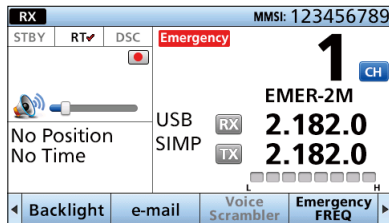

NOTE: When an Emergency FREQ channel is selected, the Voice Scrambler function cannot be turned ON.

1. Push [◀] or [▶] until **Emergency FREQ** is displayed in the Software Key area.
2. Push **Emergency FREQ** .
 - The channel is changed to an Emergency FREQ channel and **Emergency** is displayed in the Channel area.
3. Rotate [CH/GRP] or push [▲] or [▼] to select a channel.

Noise Blanker function

The Noise Blanker function reduces pulse-type noises that come from engine ignitions.

However, if the received strong signals are distorted, adjust the Noise Blanker level or turn OFF the function.

1. Push [◀] or [▶] until **NB** is displayed in the Software Key area.
2. Push **NB** to turn the function ON or OFF.
 - ① When the function is ON, "NB" is displayed in the Status area.

Noise Blanker Level

When the Noise Blanker function is ON, adjust the Noise Blanker level to reduce various pulse-type noises.

Set to between 1 and 10.

1. Push [◀] or [▶] until **NB Level** is displayed in the Software Key area.
2. Push **NB Level** .
 - The NB level setting window is displayed.
3. Push [◀]/[▼] or [▲]/[▶] to adjust the Noise Blanker level.

Squelch function

The Squelch function mutes unwanted signals such as noise or unmodulated beat signals. This function enables quiet standby.

However, when you need to receive weak signals, adjust the Squelch level, or turn OFF the function.

1. Push [◀] or [▶] until **SQL** is displayed in the Software Key area.
2. Push **SQL** to turn the function ON or OFF.
 - ① When the function is ON, "Scan" is displayed in the Status area.

S-meter Squelch Level

When the Squelch function is ON, only signals stronger than this set level are received.

Set to between 0 (open) and 100 (tight).

1. Push [◀] or [▶] until **S-SQL Level** is displayed in the Software Key area.
2. Push **S-SQL Level** .
 - The S-SQL level setting window is displayed.
3. Push [◀]/[▼] or [▲]/[▶] to adjust the Squelch level.

RF gain Level

To receive weak signals, you can set the minimum RF (Radio Frequency) gain level needed.

Set to between 0 and 9.

1. Push [◀] or [▶] until **RF Gain** is displayed in the Software Key area.
2. Push **RF Gain** .
 - The RF gain level setting window is displayed.
3. Push [◀]/[▼] or [▲]/[▶] to adjust the RF gain level.

TX Power

Change the output power level of the selected channel to High, Mid-H (Middle-High), Mid-L (Middle-Low), or Low temporarily.

1. Push [◀] or [▶] until **TX Power** is displayed in the Software Key area.
2. Push **TX Power** .
 - The output power level is changed and the selected TX power is displayed.
 - ① If no indicator is displayed in the Information area, the TX power is set to "High."

Clarity Control function

With the Clarity Control function, you can slightly shift the receive frequency, without changing the operating transmit frequency, to finely tune it. When the function is ON, adjust the receive frequency.

1. Push [◀] or [▶] until **Clarity** is displayed in the Software Key area.
2. Push **Clarity** to turn the function ON.
 - **CLARITY 0** is displayed in the Channel area.
3. Push [▲] or [▼] to adjust the receive frequency.

Voice Scrambler function

The Voice Scrambler function enables private communications. In order to receive or transmit scrambled transmissions, you must activate the function. You also need to set the “Voice Scrambler Code” in Radio Settings. (p. 66)

1. Push [◀] or [▶] until **Voice Scrambler** is displayed in the Software Key area.
2. Push **Voice Scrambler** to turn the function ON or OFF.
 - ① When the function is ON, “SCRM” is displayed in the Status area.

Transmit Frequency Monitor function

When selecting a duplex channel, the transmit frequency differs from the receive frequency. To prevent interference to other stations, the transmit frequency should be monitored before you transmit.

1. Push [◀] or [▶] until **TX FREQ Monitor** is displayed in the Software Key area.
2. Hold down **TX FREQ Monitor** to monitor the transmit frequency.
 - **TX** blinks while holding down.

Speaker Output

When the Speaker Output function is ON, an internal speaker is turned ON.

1. Push [◀] or [▶] until **Speaker Output OFF** is displayed in the Software Key area.
2. Push **Speaker Output OFF** to turn the function ON or OFF.
 - ① When the function is ON, the Software key is changed to **Speaker Output OFF**.
 - ① When the function is OFF, the Software key is changed to **Speaker Output ON**, and  is displayed in the Information area.

Automatic Gain Control OFF

The Automatic Gain Control (AGC) function prevents distortion from strong signals and maintains a constant output level.

To receive weak signals, turn OFF the function.

1. Push [◀] or [▶] until **AGC OFF** is displayed in the Software Key area.
2. Push **AGC OFF** to turn OFF the function.
 - ~~AGC~~ is displayed in the Status area.

■ Setting a temporary operating frequency

You can temporarily change the operating frequency of the selected channel. The frequency returns to the preset value after you select another channel, or turn OFF the transceiver.

1. Select a channel that is programmed near the frequency you want to receive.
2. Push [RX/TX] to select the RX mode.
 - The RX icon lights blue.
3. Enter the desired receive frequency.

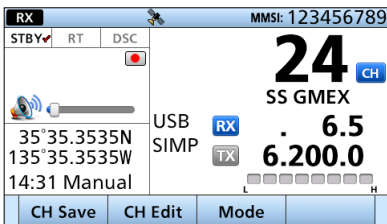

TIP:

- Select the digit using [◀] and [▶], and change the value using [▲] and [▼], or rotating [CH/GRP].
- When you select the digit using [◀] and [▶],  is displayed above the selected digit.
- You can enter a frequency directly by using the Keypad key.

NOTE:

- If you enter a frequency that is out of the frequency range, an error beep sounds, and it automatically returns to the preset frequency.
- If you enter a frequency using the Keypad key and 10 seconds have passed without pressing [ENT], the frequency automatically returns to the preset value.
- **BE SURE** to push [ENT] after enter the frequency directly by using the Keypad key.
Example: Entering 6520.0 kHz
[6] → [5] → [2] → [0] → [0] → [ENT]

4. Push [RX/TX] to select the TX mode.
 - The TX icon lights blue.



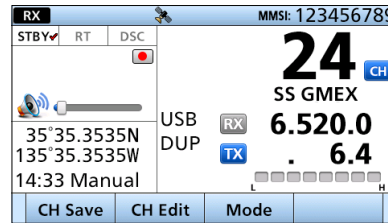

5. Enter the desired transmit frequency directly by using the Keypad key.



① See the NOTE in step 3 to enter.

6. Push [RX/TX].

TIP:

- If you want to save the entered frequency:
 1. Push **CH Save**  after the desired frequency is entered.
 - “Are You Sure?” is displayed.
 2. Push **OK** .
 3. Push [CLR].
- If you want to change and save the frequency and other settings of the selected channel, push **CH Edit**  to open the Channel Edit screen. See the next page for details.
- Push **Mode**  to change the operating mode to USB, AM, LSB, AFSK, FSK, or CW.

■ Setting a User channel, an ITU Simplex channel, or an e-mail channel

Your dealer has already preset User channels, ITU Simplex channels, and e-mail channels. Follow the instructions as described below, only when you need to edit the channels.

You can edit the following information of a User channel, an ITU Simplex channel, or an e-mail channel.

- Operating frequency
- Operating mode or operating filter
- Channel name

NOTE:

- If you edit the preset channels, you may not be able to communicate with other vessels.
- The following instructions are for User channel editing. However, you can edit an ITU Simplex channel and an e-mail channel in the same way.

Step 1. Entering the Channel Edit screen

1. Open the “User CH,” “ITU Simplex CH,” or “e-mail CH,” screen.

[MENU] > Radio Settings > **User CH**

[MENU] > Radio Settings > **ITU Simplex CH**

[MENU] > Radio Settings > **e-mail CH**

2. Select a channel you want to edit.

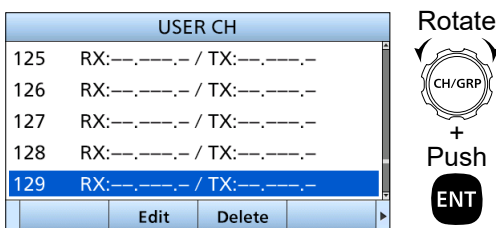

Step 2. Setting an RX and TX operating frequencies

NOTE: The RX and TX operating frequencies are the same when you select an ITU Simplex channel.

1. Select “Frequency.”

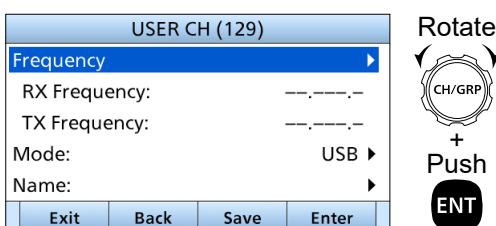

2. Enter an RX frequency, and then push **Finish**.

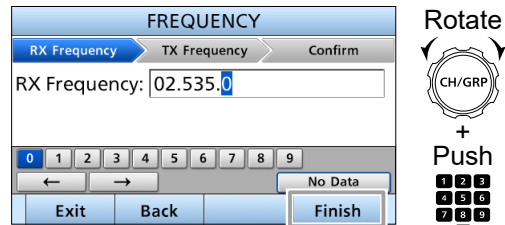

3. Enter a TX frequency, and then push **Finish**.

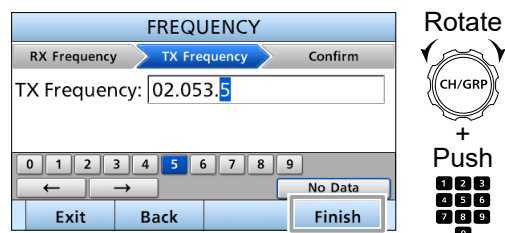

Step 3. Setting an operating mode or operating filter

1. Select “Mode.”

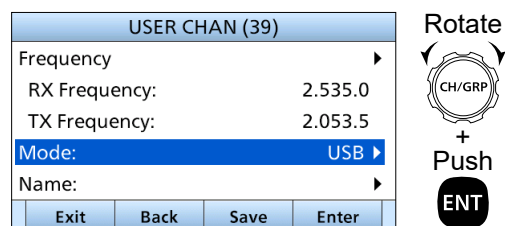

① When editing an e-mail channel, select “Filter.”

2. Select an operating mode.

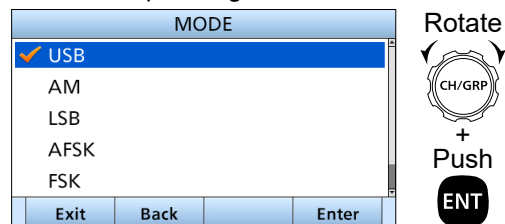

① When editing an e-mail channel, select a filter width from Wide, Middle, and Narrow in this step.

► Continued on the next page.

6 OTHER FUNCTIONS AND OPERATIONS

- Setting a User channel, an ITU Simplex channel, or an e-mail channel

Step 4. Setting a channel name

You can set a channel name of up to 10 characters for each User channel, ITU Simplex channel, or e-mail channel. This may be helpful to indicate the frequency's use, or a vessel's name.

1. Select "Name."

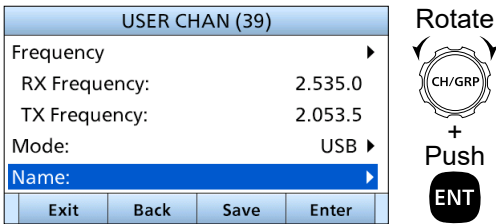

2. Enter a channel name, and then push **Finish** .



3. Push **Save** .
 - "Are You Sure?" is displayed.

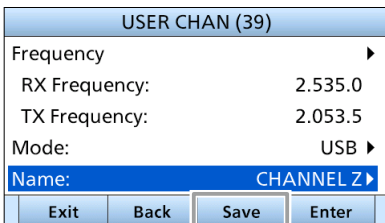

4. Push **OK**  to save the edited data.

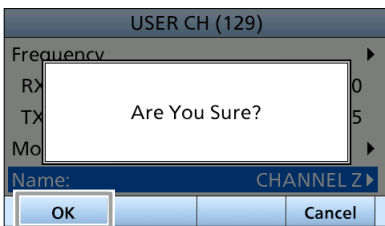

5. Push [MENU] to return to the Main screen.

■ Assigning a function

You can assign different Software Key functions to a key between Soft Key 1 and Soft Key 20. (p. 5)

You can also assign some Software Key functions to [VOL] on the controller and [P] on the optional HM-214M MICROPHONE.

◇ Assigning a Software Key function to a Software Key

1. Open "Softkey Assignment."

[MENU] > Configuration > Key Assignment > **Softkey Assignment**

2. Select a Softkey.

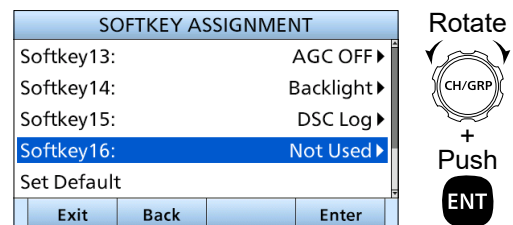

3. Select a Software Key function.

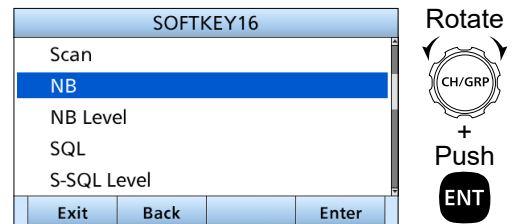

- The selected Software Key function is assigned to the Softkey.

4. Push [MENU] or **Exit**  to return to the Main screen.

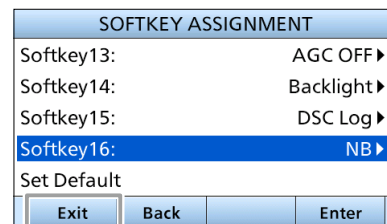

TIP: You can confirm the selected function is assigned to the Software Key after returning to the Main screen.

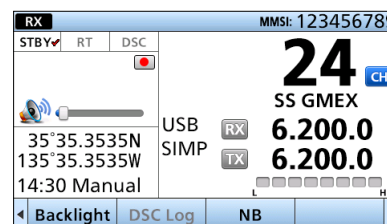

◇ Assigning a Software Key function to [VOL]

1. Open "Volume Dial Assignment."

[MENU] > Configuration > Key Assignment > **Volume Dial Assignment**

2. Select a place.

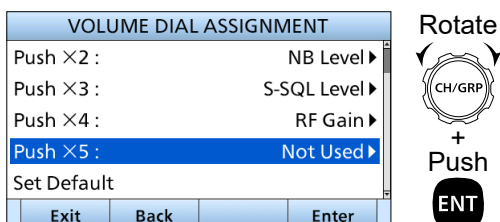

3. Select a Software Key function.

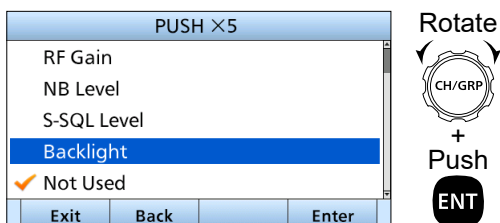

- The selected Software Key function is assigned to [VOL].

4. Push [MENU] or **Exit** to return to the Main screen.

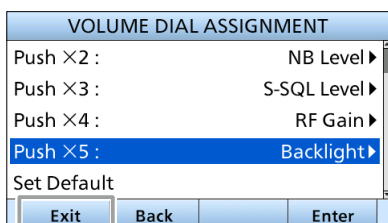

TIP: You can confirm the selected function is assigned to the Volume Dial after returning to the Main screen. (Example: When [VOL] is pushed 5 times, the Backlight setting window is displayed.)

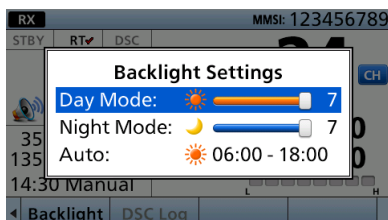

◇ Assigning a Software Key function to [P] on the HM-214H MICROPHONE

1. Open "P Key Assignment."

[MENU] > Configuration > Key Assignment > **P Key Assignment**

2. Select a Software Key function.

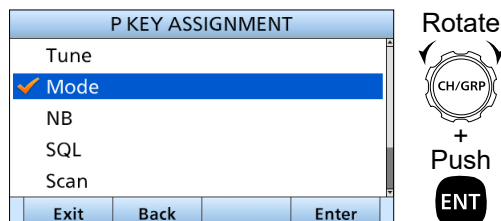

- The selected Software Key function is assigned to [P].

3. Push [MENU] or **Exit** to return to the Main screen.

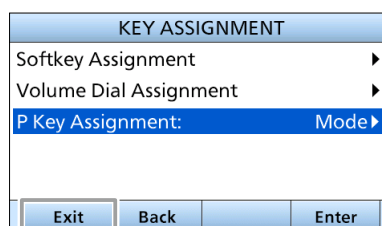

TIP: You can confirm the selected function is assigned to [P] after returning to the Main screen.

■ DSC address ID

◇ Entering an Individual or Group ID

You can enter a total of 75 Individual IDs and 25 Group IDs, and assign names to them of up to 10 characters.

1. Open "Individual ID" or "Group ID."

[MENU] > DSC Settings > **Individual ID**

[MENU] > DSC Settings > **Group ID**

- "No ID" is displayed if no ID is entered.

2. Push **Add** .

- The ID entry screen is displayed.

INDIVIDUAL ID	
STATION A	
STATION B	
<div style="display: flex; justify-content: space-between;"> Add Edit Delete ▶ </div>	

3. Select "Address."

INDIVIDUAL ID	
Address: 	
Call Frequency 	
RX Frequency: 	
TX Frequency: 	
Voice Frequency 	
<div style="display: flex; justify-content: space-between;"> Exit Back Save Enter </div>	



4. Enter an Individual or Group ID, and then push

Finish .

ADDRESS	
IND ID: 123456789	
<div style="display: flex; justify-content: space-between;"> Exit Back Finish </div>	



NOTE:

- For a Group ID, the first digit is fixed as "0."
- For any coast station ID, the first two digits are fixed as "0."

5. Select "Call frequency."

INDIVIDUAL ID	
Address: 123456789	
Call Frequency 	
RX Frequency: 	
TX Frequency: 	
Voice Frequency 	
<div style="display: flex; justify-content: space-between;"> Exit Back Save Enter </div>	



6. Enter a receive frequency, and then push **Finish** .

CALL FREQUENCY		
RX Frequency -1635.0	TX Frequency	Confirm
<div style="display: flex; justify-content: space-between;"> Exit Back Finish </div>		



7. Enter a transmit frequency, and then push **Finish** .

CALL FREQUENCY		
RX Frequency	TX Frequency -1635.0	Finish
<div style="display: flex; justify-content: space-between;"> Exit Back Finish </div>		



8. Select "Voice Frequency."

INDIVIDUAL ID	
Address: 123456789	
Call Frequency: 1635.0	
Voice Frequency 	
RX Frequency: 	
TX Frequency: 	
<div style="display: flex; justify-content: space-between;"> Exit Back Save Enter </div>	



9. Enter a receive frequency, and then push **Finish** .

VOICE FREQUENCY		
RX Frequency -1735.0	TX Frequency	Finish
<div style="display: flex; justify-content: space-between;"> Exit Back Finish </div>		



10. Enter a transmit frequency, and then push **Finish** .

VOICE FREQUENCY		
RX Frequency	TX Frequency -1755.0	Finish
<div style="display: flex; justify-content: space-between;"> Exit Back Finish </div>		



11. Select "Name."

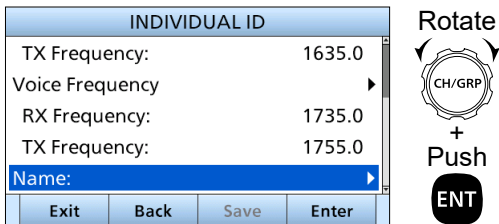

12. Enter the ID's name, and then push **Finish**.

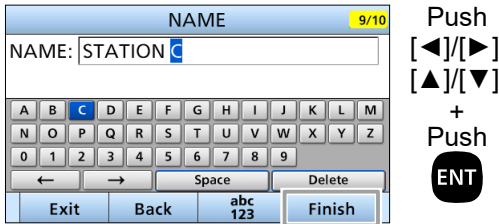

13. Push **Save**.
• "Are You Sure?" is displayed.

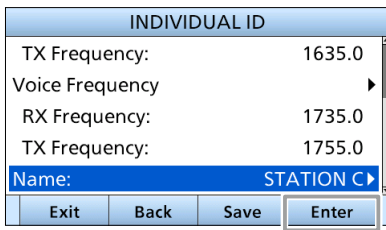

14. Push **OK**.
• The entered name is displayed.

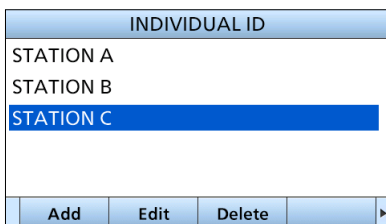
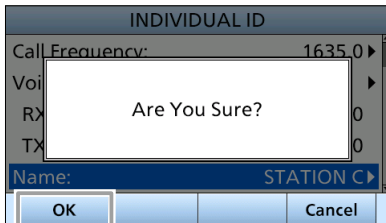

15. Push [MENU] to return to the Main screen.

◇ Delete an entered ID

(Example: Deleting an Individual ID: STATION B)

1. Open "Individual ID."

[MENU] > DSC Settings > **Individual ID**

2. Select the "STATION B," and then push **Delete**.
• "Are You Sure?" is displayed.

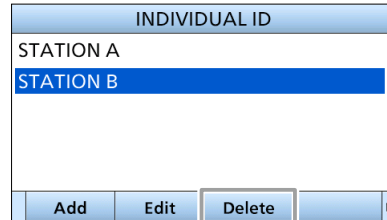

3. Push **OK**.
• The selected ID is deleted, and then returns to the previous screen.

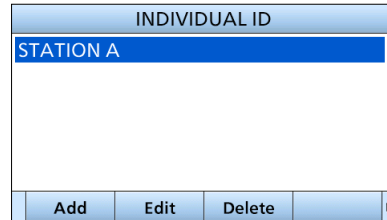
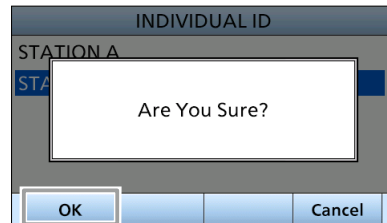

① Push **Cancel** to cancel the deletion.

TIP: You can edit an ID and its name by pushing **Edit** in step 2.

■ Entering the position data and time

A Distress call should include the vessel's position, date, and time. If no GPS data is received, manually enter the position and Universal Time Coordinated (UTC) time.

NOTE:

- Manual entry is disabled while valid GPS data is received.
- The manually entered position and time is valid only for 23.5 hours.

1. Open "Position Input."

[MENU] > DSC Settings > **Position Input**

2. Enter the latitude, and then push **Finish** .

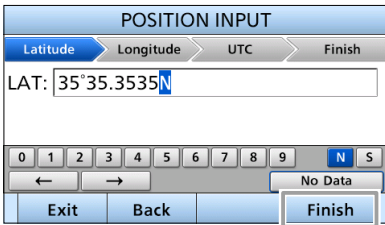

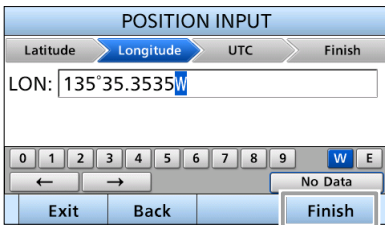

① To select 'N' (North latitude) or 'S' (South latitude), select "N" or "S" on the screen and push [ENT], or push a Keypad key when the cursor is on the 'N' or 'S.'

3. Enter the longitude and the UTC time, and then push **Finish** .



① To select 'W' (West longitude) or 'E' (East longitude), select "W" or "E" on the screen and push [ENT], or push a Keypad key when the cursor is on the 'W' or 'E.'

4. Enter the UTC time, and then push **Finish** .

- After **Finish**  is pushed, the entered position data and time is set, and the DSC setting screen is displayed.

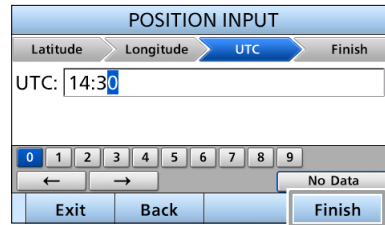

5. Push [MENU] or **Exit**  to return to the Main screen.

- The entered position data and time, and "Manual" is displayed in the Position data and Time area.

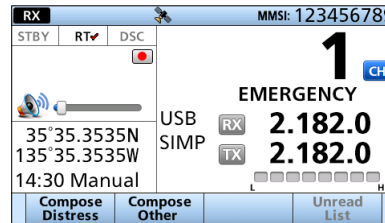

■ DSC Task mode (Single)

After sending or receiving a DSC call, the transceiver enters the DSC Task mode.

If Single Task is enabled, the transceiver can hold up only 1 task.

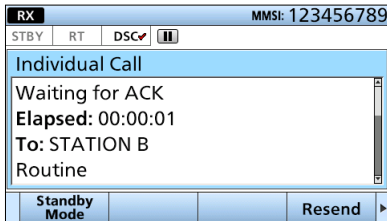

(Example: After transmitting an Individual call)

To use Single Task mode, select “Single” in “Procedure” on the Menu screen.

[MENU] > DSC Settings > **Procedure**

In the DSC Task mode, you can resend the call, or send an Acknowledgment to the caller station.

NOTE: The Task mode has a Time-out Timer (TOT) function. After a certain time has passed without any operation on a task, the transceiver automatically exits the Task mode and returns to the Main screen. When a Time-out Timer activates, an alarm sounds and a countdown message is displayed for 10 seconds. No alarm sounds and no countdown message is displayed before the Radio Telephone TOT activates.

You can set the TOT function in the Inactivity Timer menu. (p. 63)

◇ Software Key functions

While in the DSC Task mode, the following functions are displayed first.

Function	Description
Standby mode	Push to delete the task and return to the Main screen.
Resend	Push to resend the call.

The following functions may be displayed, depending on the call type.

Function	Description
Cancel	Push to send a Cancel call.
Pause	Push to pause the ‘Call Repeat’ mode, or pause the countdown.
Resume	Push to resume the countdown.
Finish	Push to exit the Distress Cancel Statement screen.
History	Push to display the Distress Call History screen.
ACK/ACK (able)	Push to send an Acknowledgment without any changes.
ACK (Unable)	Push to send an Acknowledgment, but you cannot make a call.
ACK (New CH)	Send an Acknowledgment. You can specify the Voice Communication frequency.

◇ Unread List

If the transceiver has unread DSC calls, you can enter the Unread List menu by pushing **Unread List** .

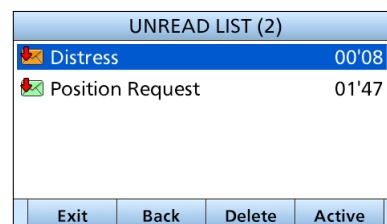
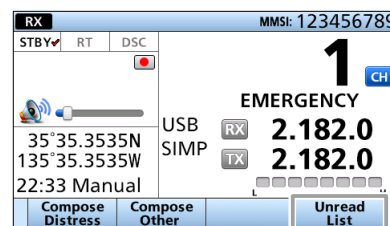

① Push **Active**  to enter the task mode.

① Push **Info**  to display the detail of the selected task.

■ DSC Task mode (Multiple)

If Multiple Task is enabled, the transceiver can hold up to 7 tasks. You can make more than 2 DSC tasks simultaneously by switching between the tasks.

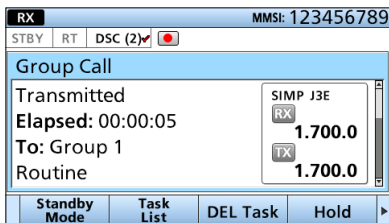

(Example: After transmitting a Group call)

To use Multiple Task mode, select “Multiple” in “Procedure” on the Menu screen.

[MENU] > DSC Settings > **Procedure**

When Multiple Task mode is activated,  is displayed on the Main screen.

NOTE: The Task mode has a Time-out Timer (TOT) function. After a certain time has passed without any operation on a task, the transceiver automatically exits the Task mode and returns to the Main screen. When a Time-out Timer activates, an alarm sounds and a countdown message is displayed for 10 seconds. No alarm sounds and no countdown message is displayed before the Radio Telephone TOT activates. You can set the TOT function in the Inactivity Timer menu. (p. 63)

◇ Software Key functions

While in the DSC Task mode, the following functions are displayed first.

Function	Description
Standby mode	Push to delete the task and return to the Main screen.
Task List	Push to display the Task list.
DEL Task	Push to delete the task and display the Task list.
Hold	Push to hold the task and display the Task list.
Resend	Push to resend the call.



The following functions may be displayed, depending on the call type.

Function	Description
Cancel	Push to send a Cancel call.
Pause	Push to pause the ‘Call Repeat’ mode, or pause the countdown.
Resume	Push to resume the countdown.
Finish	Push to exit the Distress Cancel Statement screen.
History	Push to display the Distress Call History screen.
ACK/ACK (able)	Push to send an Acknowledgment without any changes.
ACK (Unable)	Push to send an Acknowledgment, but you cannot make a call.
ACK (New CH)	Send an Acknowledgment. You can specify the Voice Communication frequency.

◇ Task List

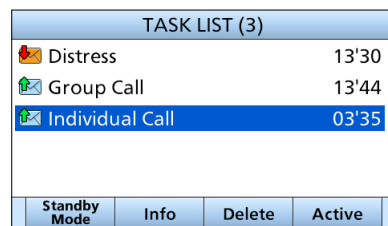
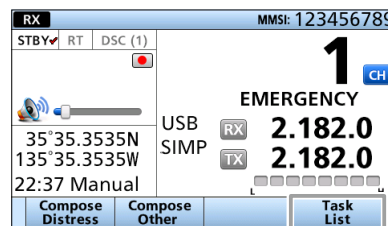
When one or more tasks are held, you can display the Task List screen by pushing . The number of tasks is displayed at the top of the screen.



- ① Push  to enter the Task mode.
- ① Push  to display the detail of the selected task.

■ Sending DSC calls (Distress)

A Distress call should be sent if, in the opinion of the captain, the vessel or a person is in distress and requires immediate assistance.

NEVER MAKE A DISTRESS CALL IF YOUR VESSEL OR A PERSON IS NOT IN AN EMERGENCY. A DISTRESS CALL SHOULD BE MADE ONLY WHEN IMMEDIATE HELP IS NEEDED.

◇ Simple call

1. Confirm that no Distress call is being received.
2. While lifting up the key cover, hold down [DISTRESS] for 3 seconds until you hear 3 short countdown beeps and a long beep sound.

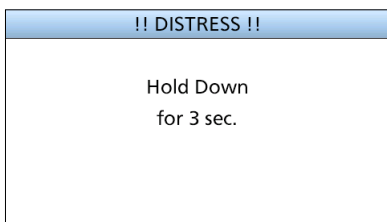

- The backlight blinks.
- ① All Emergency Frequencies are automatically selected to send a Distress call.

3. After sending, wait for an Acknowledgment call.

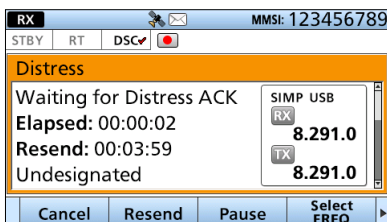

- "Waiting for ACK" is displayed.
- The Distress call is automatically sent every 4 minutes, until an Acknowledgment is received, or a Distress Cancel call is sent.

4. When you receive an Acknowledgment, an alarm sounds. Push **Alarm Off** to turn OFF the alarm.



5. Push **Close Call RCVD Window**.

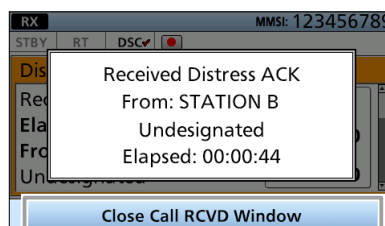

6. Hold down [PTT], and then explain your situation.
7. After you have finished your explanation, push **Standby Mode**, and then **OK** to return to the Main screen.

TIP: A default Distress alert contains:

- Nature of distress: Undesignated distress
- Position information: The latest GPS, or manually input position, that is held for 23.5 hours, or until you turn OFF the transceiver.

■ Sending DSC calls (Distress)

◇ Regular call

Select the nature of the Distress call to include in the Regular Distress call.

1. Push **Compose Distress** .
 - The "COMPOSE DISTRESS" screen is displayed.
 - ① To display the screen from the Menu screen:

[MENU] > **Compose Distress**

Step 1. Setting a "Nature of Distress"

1. Select "Nature of Distress."

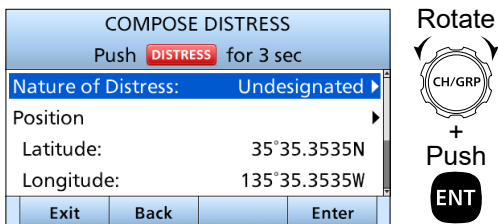

2. Select the nature of the Distress. (Example: Fire, Explosion)
 - The setting is saved and returns to the previous screen.

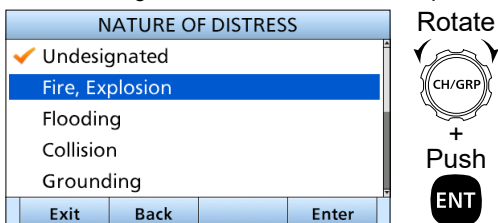

Step 2. Entering a "Position"

NOTE: When your position data and time are valid, you can skip this step and go to step 3.

1. Select "Position."

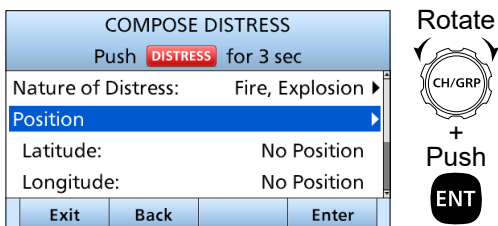

2. Enter your position data and time.
 - See page 26 for entering details.

Step 3. Setting a communication frequency

1. Select "Attempt."

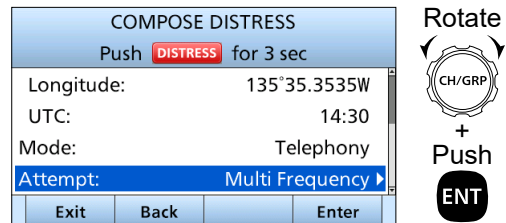

2. Select an option. (Example: Multi Frequency)
 - The setting is saved and returns to the previous screen.

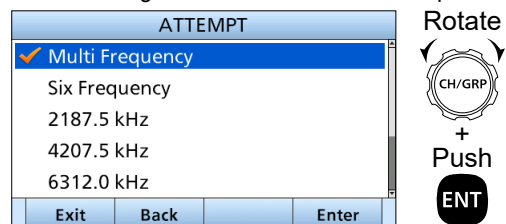

Step 4. Sending

1. While lifting up the key cover, hold down [DISTRESS] for 3 seconds until you hear 3 short countdown beeps and a long beep sound.
 - The backlight blinks.

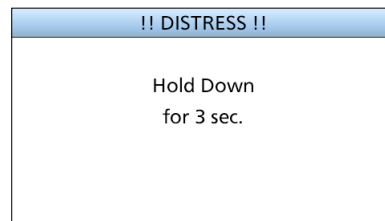

2. After sending, wait for an Acknowledgment call.
 - "Waiting for Distress ACK" is displayed.
 - The Distress call is automatically sent every 3.5 to 4.5 minutes, until an Acknowledgment is received, or a Distress Cancel call is sent.

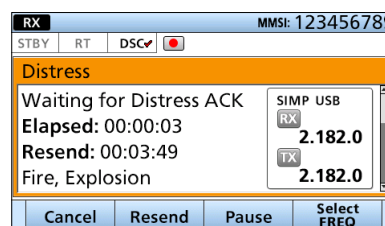

3. When you receive an Acknowledgment, an alarm sounds. Push **Alarm Off**  to turn OFF the alarm.





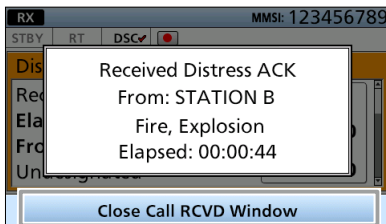

4. Push **Close Call RCVD Window** .

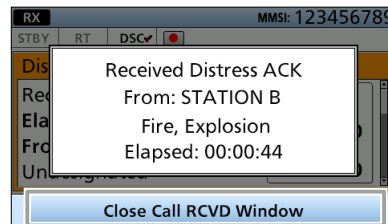

5. Push **Close Call RCVD Window** .



5. Hold down [PTT], and then explain your situation.
 6. After you have finished your explanation, push **Standby Mode** , and then **OK**  to return to the Main screen.

6. Hold down [PTT], and then explain your situation.
 7. After you have finished your explanation, push **Standby Mode** , and then **OK**  to return to the Main screen.

◇ Resending a Distress call

While waiting for an Acknowledgment, you can resend the call (Repeat call).

1. When “Waiting for ACK” screen is displayed, push **Resend** .
 • The “RESEND DISTRESS” screen is displayed.

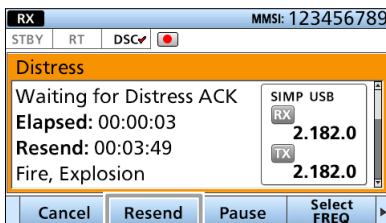

① See the pages 27 and 28 for details of the Software Key functions in the DSC Task mode.

2. Select options of “Position” and “Attempt” again if needed.
 3. While lifting up the key cover, hold down [DISTRESS] for 3 seconds until you hear 3 short countdown beeps and a long beep sound.
 • The backlight blinks.

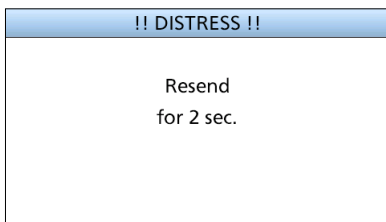

4. When you receive an Acknowledgment, an alarm sounds. Push **Alarm Off**  to turn OFF the alarm.

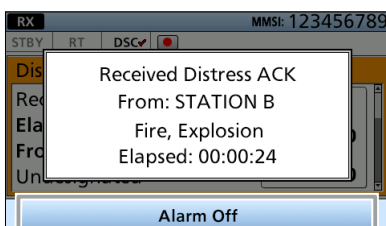



TIP:

Transmitting:

- A default Distress alert contains:
 - Nature of distress: Undesignated distress
 - Position information: The latest GPS, or manually input position, that is held for 23.5 hours, or until you turn OFF the transceiver.
- While holding down [DISTRESS], count down beeps sound, and both the key and display backlights blink.
- All Emergency Frequencies are automatically selected to send a Distress call. You can select one or more Emergency Frequencies to send a Regular Distress call.

Waiting for an Acknowledgment:

- The Distress call is automatically transmitted every 3.5 to 4.5 minutes, until an Acknowledgment is received (Call Repeat function), or you make a Distress Cancel call. (p. 32)
- To manually transmit a Distress repeat call, push **Resend** .
- To display the transmitted Distress call information, rotate [CH/GRP], or push [▲] or [▼].
- To pause the Call Repeat function, push **Pause** . To resume it, push **Resume Countdown** .

7 DSC OPERATION

■ Sending DSC calls (Distress)

◇ Distress Cancel call

If you have accidentally made a Distress call, or made an incorrect Distress call, send a Distress Cancel call to cancel the call as soon as possible while waiting for an Acknowledgment. Be sure to report the purpose of the cancellation.

While transmitting a Distress call

1. Push **Cancel** .



2. Confirm the content and push **Continue** .
 - The Distress cancel is sent.

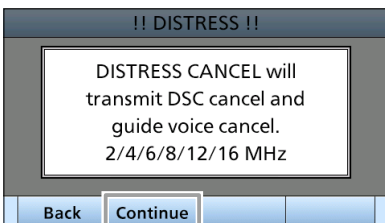

- ① The frequencies that you have to send voice cancel messages are displayed. (Example: 2/4/6/8/12/16 MHz)
- ① To cancel the Distress Cancel call, push **Back** .

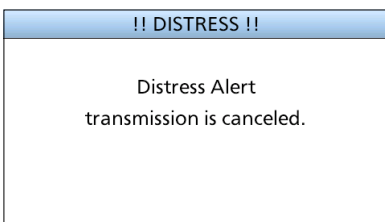
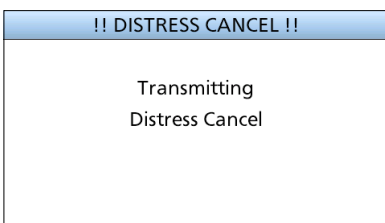

3. After sending, the following screen is displayed. Push **Select FREQ** .

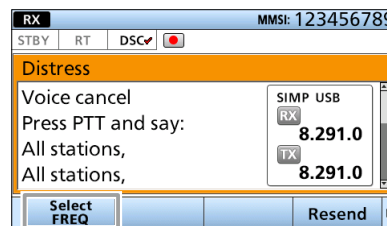

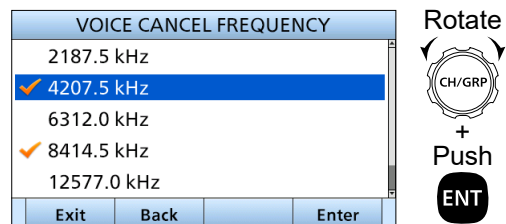

4. Select a frequency to send a voice cancel message.

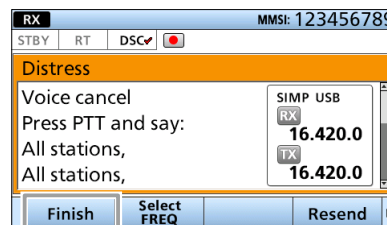

- ① The check mark shows that the Distress call on the selected frequency is cancelled by sending Voice Cancel message.
5. Hold down [PTT] to report the purpose of the cancellation.
 - ① You can display the wording of the cancellation by rotating [CH/GRP], or pushing [▲] or [▼].
 6. Repeat steps 3 to 5 to cancel on all frequencies.
 7. After sending a voice cancel message on all frequencies, **Finish** is displayed. Push **Finish** .



8. Push **Standby Mode** , and then **OK**  to return to the Main screen.

While waiting for Distress ACK

1. When “Waiting for Distress ACK” is displayed, push **Cancel** [C].

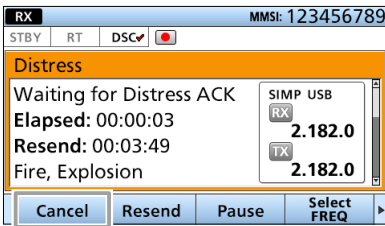

① See pages 27 and 28 for details of the Software Key functions in the DSC Task mode.

2. Push **Continue** [F] to send the Distress Cancel call.
 - The Distress cancel is sent.

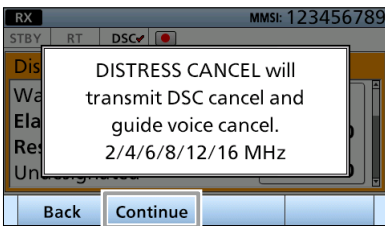

① The frequencies that you have to send voice cancel messages are displayed. (Example: 2/4/6/8/12/16 MHz)

- ① To cancel the Distress Cancel call, push **Back** [C].



3. After sending, the following screen is displayed. Push **Select FREQ** [F].

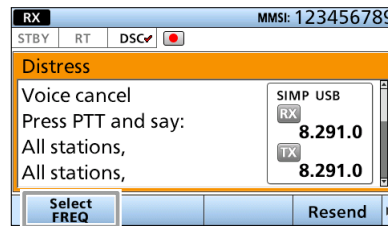

4. Select a frequency to send a voice cancel message.

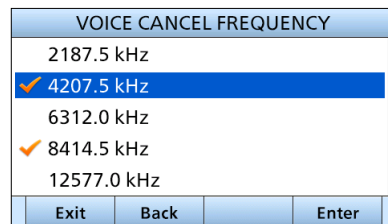

① The check mark shows that the Distress call on the selected frequency is cancelled by sending Voice Cancel message.

5. Hold down [PTT] to report the purpose of the cancellation.
 - ① You can display the wording of the cancellation by rotating [CH/GRP], or pushing [▲] or [▼].
6. Repeat steps 3 to 5 to cancel on all frequencies.
7. After sending a voice cancel message on all frequencies, **Finish** is displayed.

Push **Finish** [F].

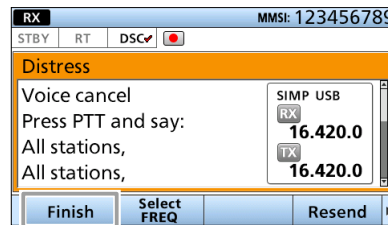

8. Push **Standby Mode** [M], and then **OK** [O] to return to the Main screen.

7 DSC OPERATION

■ Sending DSC calls (Distress)

◇ Sending a Distress Relay Acknowledgment

You can send the Distress Relay Acknowledgment only after the Distress Relay call is received.

1. Push **Alarm Off** to turn OFF the alarm while a Distress Relay call is being received.



① When “Accept after 10 sec.” or “Ignore after 10 sec.” is selected in “CH Auto Switch” setting, the countdown is started. (p. 58)

2. Push **Accept**.
 - The received call’s information is displayed.

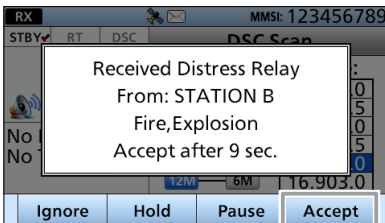

- ① If you cannot communicate, and want to return to the Main screen, push **Ignore**.
- ① If you want to put the task on hold, push **Hold**.
- ① If you want to pause the countdown, push **Pause**.

3. Push **ACK (Relay)**.
 - The Call Contents screen is displayed.

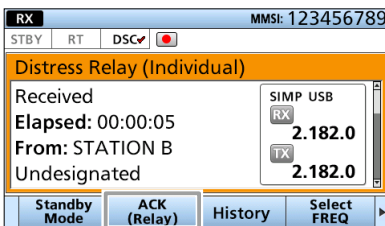

4. Confirm the contents.

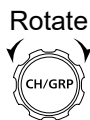
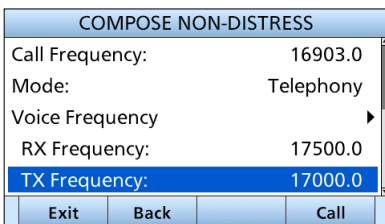

5. Push **Call** to send a Distress Relay Acknowledgment.
6. After sending, the following screen is displayed.

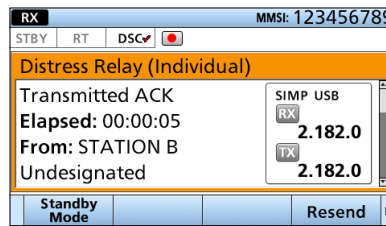

7. Hold down [PTT] to talk with the vessel in distress.
8. Push **Standby Mode**, and then **OK** to return to the Main screen.

TIP: When you push **Pause** in step 2, the countdown will be paused. Push **Resume** to restart the countdown.

■ Sending DSC calls (other)

◇ Sending an Individual call

An Individual call enables you to send a DSC signal to only a specific station.

You can communicate after receiving the Acknowledgment “ACK (able).”

① You can send an Individual call to a pre-entered Individual address, or manually enter the address before sending. (p. 24)

1. Push **Compose Other** .
 - The “COMPOSE NON-DISTRESS” screen is displayed.

[MENU] > **Compose Non-Distress**

2. Select “Address.”

Rotate
CH/GRP
+
Push
ENT

3. Select an Individual address, or “Manual Input.”

Rotate
CH/GRP
+
Push
ENT

NOTE: When you select “Manual Input” in this step, push the Keypad key to manually enter an Individual ID.

4. Select “Call frequency.”

Rotate
CH/GRP
+
Push
ENT

5. Select a Call frequency, or “Manual Input.”

Rotate
CH/GRP
+
Push
ENT

NOTE: When you select “Manual Input” in this step, push the Keypad key to manually enter a Call frequency.

6. Select “Voice Frequency.”

Rotate
CH/GRP
+
Push
ENT

7. Select a voice frequency, or “Manual Input.”

Rotate
CH/GRP
+
Push
ENT

NOTE: When you select “Manual Input” in this step, push the Keypad key to manually enter a voice frequency.

8. Push **Call** to send an Individual call.
 - “Transmitting Individual Call” is displayed, and then “Waiting for ACK” is displayed.

① See pages 27 and 28 for details of the Software Key functions in the DSC Task mode.

► Continued on the next page.

■ Sending DSC calls (other)

◇ Sending an Individual call (continued)

9. When you receive an Acknowledgment “Able to comply”:

- An alarm sounds.
- The following screen is displayed.

Push **Alarm Off** to turn OFF the alarm.

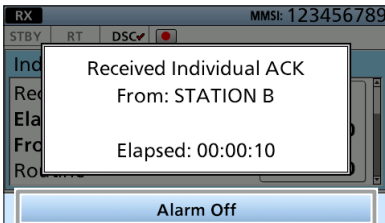

10. Push **Close Call RCVD Window** .

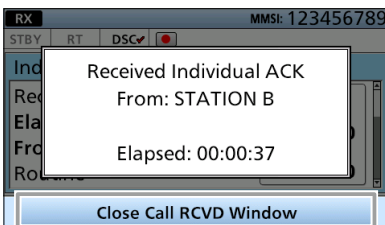

11. Hold down [PTT], and then explain your situation.

12. After you have finished your explanation, push **Standby Mode** , and then **OK** to return to the Main screen.

TIP: If you received an Acknowledgment “Unable to comply”:

1. Push **Alarm Off** to turn OFF the alarm.
 - The Acknowledge information is displayed.
2. Push **Standby Mode** , and then **OK** to return to the Main screen.

◇ Sending an Individual Acknowledgment

When you have received an Individual call (p. 48), send an Acknowledgment to the calling station. When “Manual” is selected in “Individual ACK” (p. 57), you can select an appropriate Acknowledgment type.

1. While an Individual call is being received, push **Alarm Off** to turn OFF the alarm.

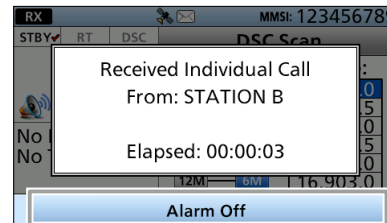

- The received call’s information is displayed.

2. Push **Accept** .

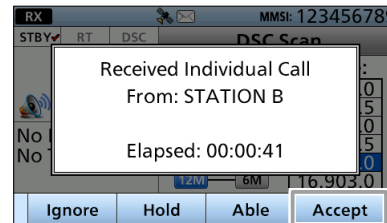

① If you want to immediately send an Acknowledgment “Able to comply,” push **Able** .

① If you cannot communicate, and want to return to the Main screen, push **Ignore** .

① If you want to put the task on hold, push **Hold** .

3. Push a key to select an Acknowledgment option.

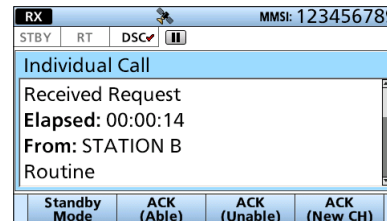

- The Call Contents screen is displayed.

TIP:

- **ACK (Able)** (Able to comply): Sends an Acknowledgment without any changes.
- **ACK (Unable)** (Unable to comply): Sends an Acknowledgment but cannot communicate.
- **ACK (New Ch)** (Propose new channel): Able to communicate but propose another Voice Frequency. Enter the frequency in “Voice Frequency” in the next step.

4. Confirm the contents.

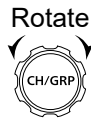
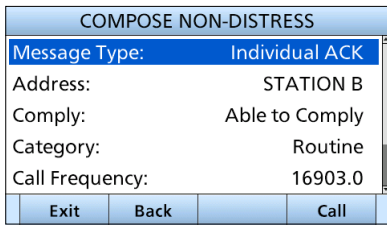

5. Push **Call** to send an Individual Acknowledgment.
 • “Transmitting Individual ACK” is displayed, and then “Individual Call” is displayed.

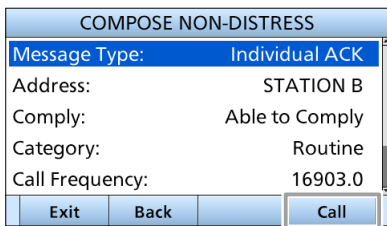

① See pages 27 and 28 for details of the Software Key functions in the DSC Task mode.

6. Hold down [PTT] to talk.
 7. Push **Standby Mode** , and then **OK** to return to the Main screen.

TIP: When “Individual ACK” is set to “AUTO,” the transceiver automatically transmits an Individual Acknowledgment. (p. 57)

◇ Sending a Group call

A Group call enables you to send a DSC call to only a specific group.

① You can send a Group call to a pre-entered group address, or manually enter the address before sending. (p. 24)

1. Push **Compose Other** .

- The “COMPOSE NON-DISTRESS” screen is displayed.

① To display the screen from the Menu screen:

[MENU] > **Compose Non-Distress**

2. Select “Message Type.”

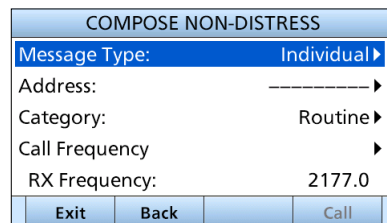

3. Select “Group.”

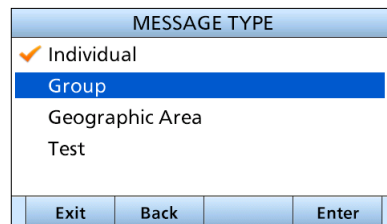

① “Category” is fixed to “Routine.”

4. Select “Address.”

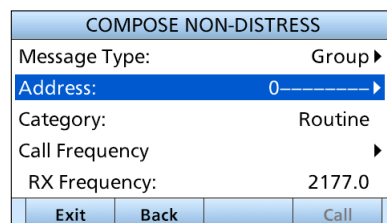

5. Select a Group ID, or “Manual Input.”

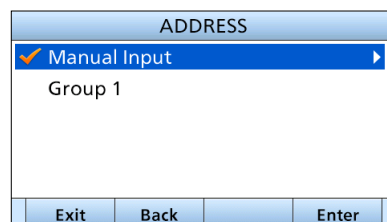

NOTE: When you select “Manual Input” in this step, push the Keypad key to manually enter an Group ID.

► Continued on the next page



7 DSC OPERATION

■ Sending DSC calls (other)

◇ Sending a Group call (continued)



6. Select "Call frequency."

COMPOSE NON-DISTRESS	
Message Type:	Group ▶
Address:	098765432 ▶
Category:	Routine
Call Frequency:	2177.0 ▶
Mode:	Telephony
Exit	Back
	Call

Rotate

 +
 Push

7. Select a Call frequency, or "Manual Input."



CALL FREQUENCY	
✓ Manual Input	▶
INTER12-1	
INTER12-2	
INTER12-3	
INTER16-1	
Exit	Back
	Enter

Rotate

 +
 Push

NOTE: When you select "Manual Input" in this step, push the Keypad key to manually enter a Call frequency.



8. Select "Voice Frequency."

COMPOSE NON-DISTRESS	
Address:	098765432 ▶
Category:	Routine
Call Frequency:	16903.0 ▶
Mode:	Telephony
Voice Frequency:	16528.0 ▶
Exit	Back
	Call

Rotate

 +
 Push

9. Select a voice frequency, or "Manual Input."

VOICE FREQUENCY	
✓ Manual Input	▶
Channel	▶
Exit	Back
	Enter

Rotate

 +
 Push

NOTE: When you select "Manual Input" in this step, push the Keypad key to manually enter a voice frequency.



10. Push **Call**  to send a Group call.

- "Transmitting Group Call" is displayed, and then "Group Call" is displayed.

COMPOSE NON-DISTRESS	
Address:	098765432 ▶
Category:	Routine
Call Frequency:	16903.0 ▶
Mode:	Telephony
Voice Frequency:	17000.0 ▶
Exit	Back
	Call

① See pages 27 and 28 for details of the Software Key functions in the DSC Task mode.

11. Hold down [PTT] to talk.

12. Push **Standby Mode** , and then **OK**  to return to the Main screen.

◇ Sending a Geographical Area call

Send a Geographical Area call when it is necessary to send an urgent or safety message announcement to the vessels in a particular area.

1. Push **Compose Other** .
 - The “COMPOSE NON-DISTRESS” screen is displayed.
 - ① To display the screen from the Menu screen:

[MENU] > **Compose Non-Distress**

2. Select “Message Type.”

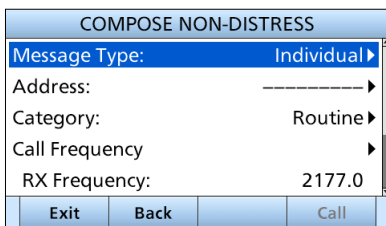

3. Select “Geographic Area.”

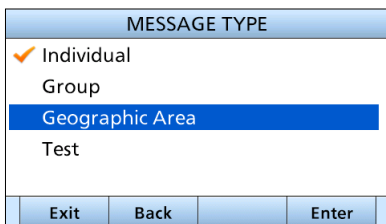

4. Select “Area.”

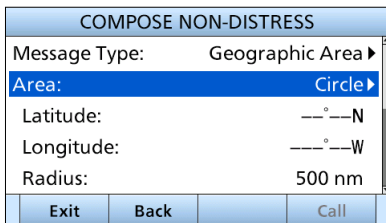

5. Select “Circle” or “Quadrant.”

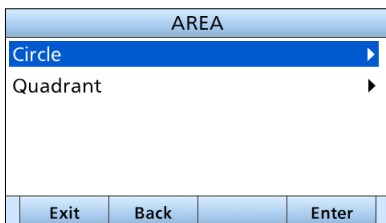

- Circle: See the following steps.
- Quadrant: See the next page.

When “Circle” is selected:

You can send a Geographical Area call within the area covered by a set nautical mile radius from your position.

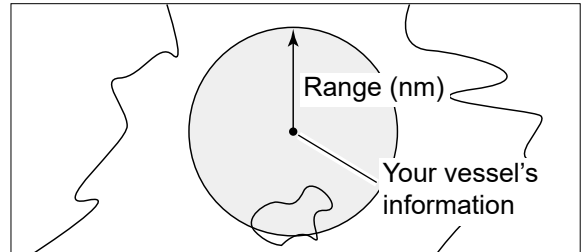

1. Enter the latitude of your position, and then push **Finish** .

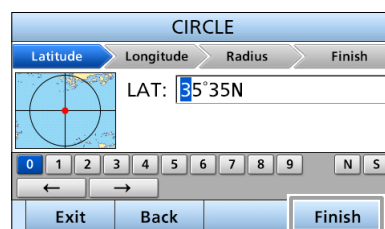

- ① Displays your vessel's position data as the default.
- ① To select 'N' (North latitude) or 'S' (South latitude), select “N” or “S” on the screen and push [ENT], or push a Keypad key when the cursor is on the 'N' or 'S.'

2. Enter the longitude of your position, and then push **Finish** .

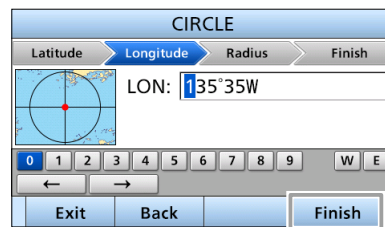

- ① Displays your vessel's position data as the default.
- ① To select 'W' (West longitude) or 'E' (East longitude), select “W” or “E” on the screen and push [ENT], or push a Keypad key when the cursor is on the 'W' or 'E.'

3. Enter the radius of the Geographical Area call area, and then push **Finish** .

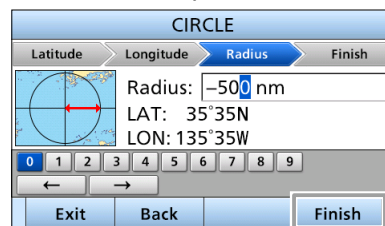

4. Go to step 6 on the next page.

▶ Continued on the next page

7 DSC OPERATION

■ Sending DSC calls (other)

◇ Sending a Geographical Area call (continued)

When "Quadrant" is selected:

You can send a Geographical Area call within the square as shown below. Your vessel's position is the upper left corner of the square.

● Example

Latitude: 20°N Height: 10°
Longitude: 100°W Width: 20°

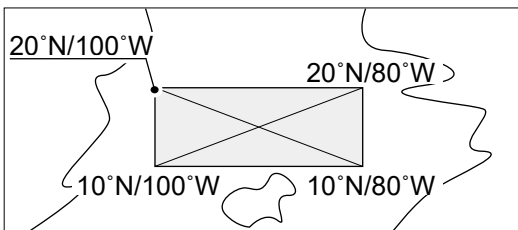

1. Enter the latitude of your position, and then push **Finish**

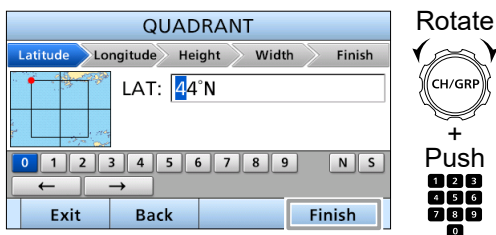

① Displays your vessel's position data as the default.

① To select 'N' (North latitude) or 'S' (South latitude), select "N" or "S" on the screen and push [ENT], or push a Keypad key when the cursor is on the 'N' or 'S.'

2. Enter the longitude of your position, and then push **Finish**

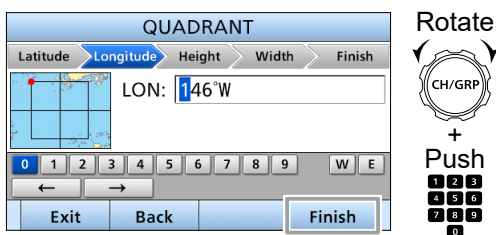

① Displays your vessel's position data as the default.

① To select 'W' (West longitude) or 'E' (East longitude), select "W" or "E" on the screen and push [ENT], or push a Keypad key when the cursor is on the 'W' or 'E.'

3. Enter the height of the Geographical Area call area, and then push **Finish**

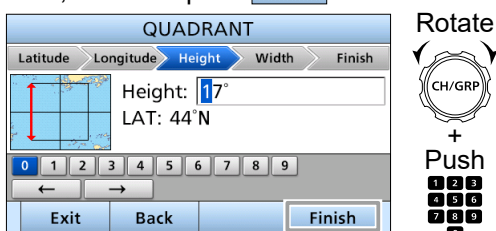

4. Enter the width of the Geographical Area call area, and then push **Finish**

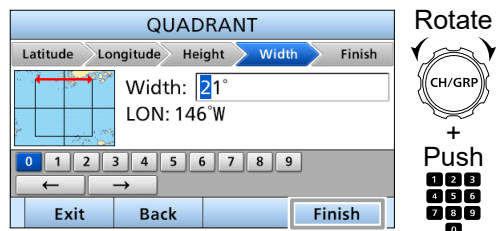

5. Go to step 6 as shown below.

6. Select "Category."

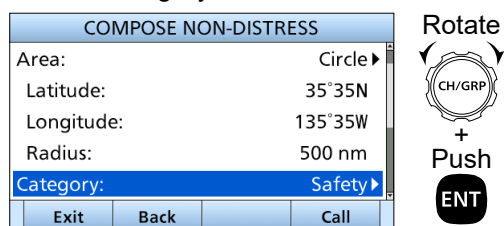

7. Select an option.

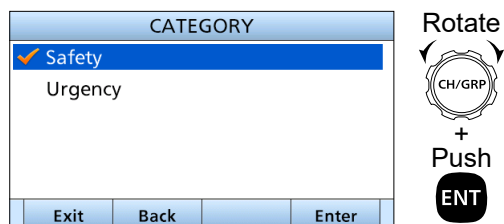

8. Select "Call frequency"

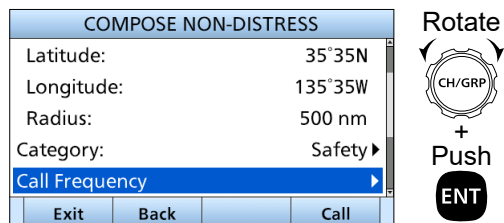

9. Select a Call frequency.

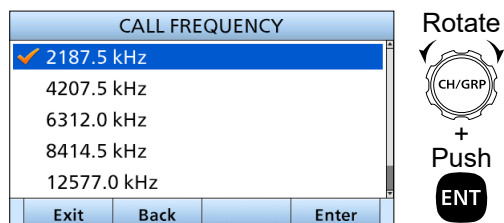

10. Select "Voice Frequency."

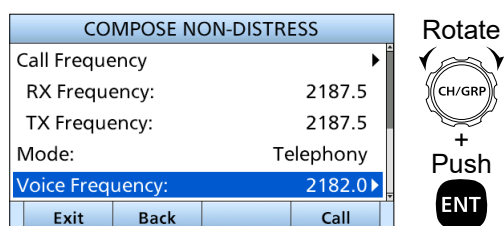

11. Select a voice frequency, or “Manual Input.”

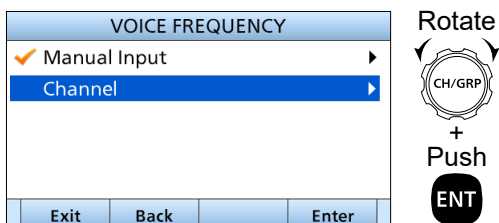

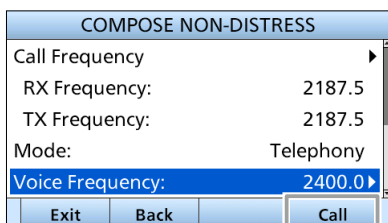

NOTE: When you select “Manual Input” in this step, push the Keypad key to manually enter a voice frequency.

12. Push **Call**  to send a Geographical Area call.
- “Transmitting Geographical Call” is displayed, and then “Geographical Call” is displayed.



① See pages 27 and 28 for details of the Software Key functions in the DSC Task mode.

13. Hold down [PTT] to talk.
14. Push **Standby Mode** , and then **OK**  to return to the Main screen.

◇ Sending a Test call

You should avoid testing calls on the exclusive DSC Distress channels and safety calling channels. When you cannot avoid testing on a Distress or safety channel, you should indicate that these are test calls. Normally the Test call would require no further calls between the two stations involved.

① You can send a Test call to a pre-entered Individual address, or manually enter the address before sending. (p. 24)

1. Push **Compose Other** .
 - The “COMPOSE NON-DISTRESS” screen is displayed.

① To display the screen from the Menu screen:
[MENU] > Compose Non-Distress

2. Select “Message Type.”

COMPOSE NON-DISTRESS	
Message Type:	Individual ▶
Address:	-----▶
Category:	Routine ▶
Call Frequency	▶
RX Frequency:	2177.0
Exit	Back
Call	

Rotate

 +
 Push

3. Select “Test.”

MESSAGE TYPE	
✓ Individual	
Group	
Geographic Area	
Test	
Exit	Back
Enter	

Rotate

 +
 Push

4. Select “Address.”

COMPOSE NON-DISTRESS	
Message Type:	Test ▶
Address:	-----▶
Category:	Safety
Call Frequency	▶
RX Frequency:	2187.5
Exit	Back
Call	

Rotate

 +
 Push

5. Select an Individual address, or “Manual Input.”

ADDRESS	
✓ Manual Input	▶
STATION A	
STATION B	
STATION C	
Exit	Back
Enter	

Rotate

 +
 Push

NOTE: When you select “Manual Input” in this step, push the Keypad key to manually enter an Individual ID.

6. Select “Call frequency.”

COMPOSE NON-DISTRESS	
Message Type:	Test ▶
Address:	STATION B ▶
Category:	Safety
Call Frequency:	2187.5 ▶
Exit	Back
Call	

Rotate

 +
 Push

7. Select a Call frequency.

CALL FREQUENCY	
✓ 2187.5 kHz	
4207.5 kHz	
6312.0 kHz	
8414.5 kHz	
12577.0 kHz	
Exit	Back
Enter	

Rotate

 +
 Push

8. Push **Call** to send a Test call.

• “Transmitting Geographical Call” is displayed, and then “Geographical Call” is displayed.

COMPOSE NON-DISTRESS	
Message Type:	Test ▶
Address:	STATION B ▶
Category:	Safety
Call Frequency:	4207.5 ▶
Exit	Back
Call	

Rotate

 +
 Push

① See pages 27 and 28 for details of the Software Key functions in the DSC Task mode.

9. Push **Standby Mode** , and then **OK** to return to the Main screen.

◇ Sending a Test call Acknowledgment

When you have received a Test call (p. 52), send an Acknowledgment to the calling station. When “Test ACK” is set to “Manual” (p. 57), do the following steps to send an Acknowledgment.

1. While a Test call is being received, push **Alarm Off** to turn OFF the alarm.

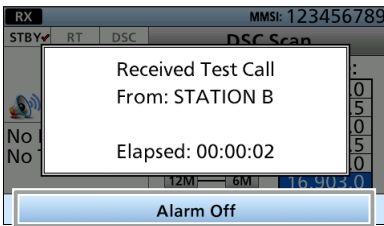

2. Push **Accept** .
 - The received call's information is displayed.

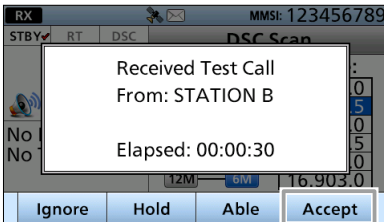

- ① If you want to immediately send an Acknowledgment, push **Able** .
- ① If you cannot communicate, and want to return to the Main screen, push **Ignore** .
- ① If you want to put the task on hold, push **Hold** .

3. Push **ACK** .
 - The Call Contents screen is displayed.

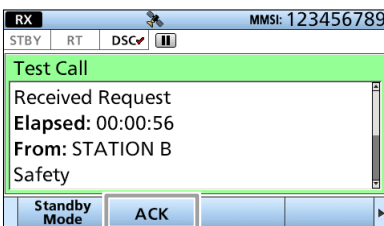

4. Confirm the contents.

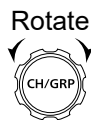
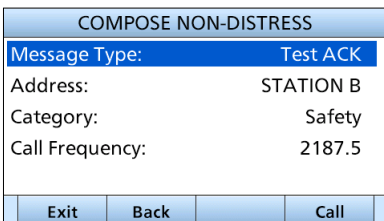

5. Push **Call** to send a Test Acknowledgment.
6. Push **Standby Mode** , and then **OK** to return to the Main screen.

TIP: When “Test ACK” is set to “AUTO,” the transceiver automatically transmits a Test Acknowledgment. (p. 57)

■ Receiving DSC calls (Distress)

The transceiver receives Distress calls, Distress Acknowledgments, and Distress Cancel calls. When you receive a call, an Emergency Alarm sounds.

NOTE:  continuously blinks while transceiver has DSC call or an unread DSC message in the Received Call Log. (p. 54)

◇ Receiving a Distress call

IMPORTANT!

Distress call reception should stop after one sequence because the coast station should send back an Acknowledgment to the vessel. If the Distress call continues, even after the coast station sends back an Acknowledgment, the vessel in distress may not receive it.

When a Distress call is received:

- The emergency alarm sounds until you turn it OFF.
- “Received Distress” is displayed.

1. Push **Alarm Off**  to turn OFF the alarm.

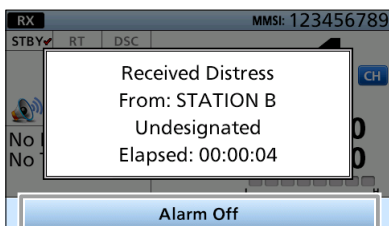



① When “Accept after 10 sec.” or “Ignore after 10 sec.” is selected in “CH Auto Switch” setting, the countdown is displayed on the bottom of the window. (p. 58)

After 10 seconds have passed since **Alarm Off**  is pushed, the screen will move to the DSC Task screen, or return to the Main screen.

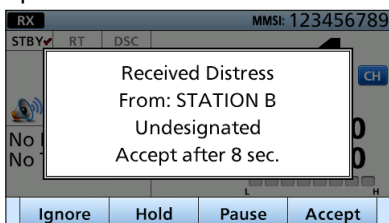
2. Push the Software Key below the intended operation.



Ignore : Ignores the call and returns to the Main screen.

Hold : Puts the RX task on hold, and returns to the Main screen.



Pause : Pauses the countdown.

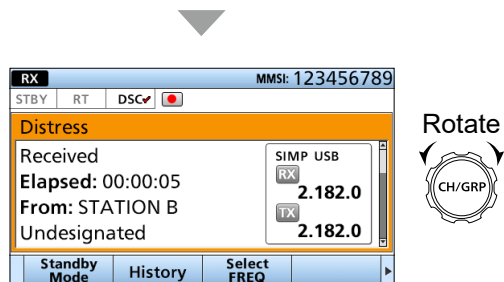

Accept : Enters the DSC Task mode immediately.



- One of the Emergency Frequencies is automatically selected. Monitor it because a coast station may require assistance.
- Rotate [CH/GRP] to confirm the call contents.

① See pages 27 and 28 for details of the Software Key functions in the DSC Task mode.

3. Push **Standby Mode** , and then **OK**  to return to the Main screen.

TIP: When you push **Pause**  in step 2, the countdown will be paused. Push **Resume Countdown**  to restart the countdown.

◇ Receiving a Distress Acknowledgment

When a Distress Acknowledgment is received:



- The emergency alarm sounds until you turn it OFF.
 - “Received Distress ACK” is displayed.
1. Push **Alarm Off**  to turn OFF the alarm.

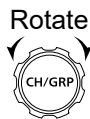
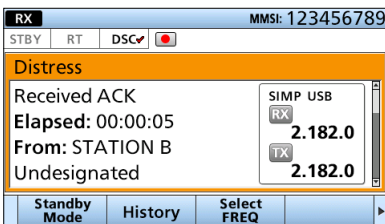
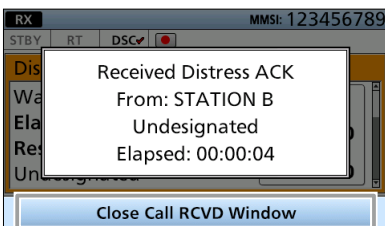

2. Push **Close Call RCVD Window** .



- One of the Emergency Frequencies is automatically selected. Monitor it because a coast station may require assistance.
 - Rotate [CH/GRP] to confirm the call contents.
- ① See pages 27 and 28 for details of the Software Key functions in the DSC Task mode.

3. Push **Standby Mode** , and then **OK**  to return to the Main screen.

◇ Receiving a Distress Cancel call

When a Distress Cancel call is received:



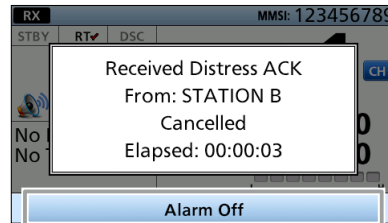

- The emergency alarm sounds until you turn it OFF.
 - “Received Distress ACK” is displayed.
1. Push **Alarm Off**  to turn OFF the alarm.

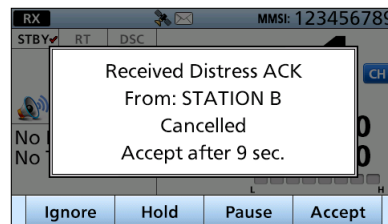

- ① When “Accept after 10 sec.” or “Ignore after 10 sec.” is selected in “CH Auto Switch” setting, the countdown is displayed on the bottom of the window. (p. 58)
After 10 seconds have passed since **Alarm Off**  is pushed, the screen will move to the DSC Task screen, or return to the Main screen.

2. Push the Software Key below the intended operation.



- Ignore** : Ignores the call and returns to the Main screen.
- Hold** : Puts the RX task on hold, and returns to the Main screen.
- Pause** : Pauses the countdown.
- Accept** : Enters the DSC Task mode immediately.

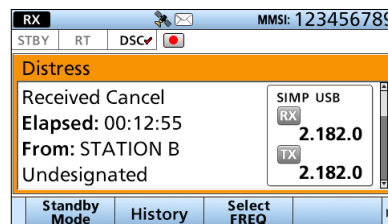



- One of the Emergency Frequencies is automatically selected. Monitor it because a coast station may require assistance.
 - Rotate [CH/GRP] to confirm the call contents.
- ① See pages 27 and 28 for details of the Software Key functions in the DSC Task mode.



▶ Continued on the next page

7 DSC OPERATION

■ Receiving DSC calls (Distress)

◇ Receiving a Distress Cancel call (continued)

3. Push **Standby Mode** , and then **OK**  to return to the Main screen.

TIP: When you push **Pause**  in step 2, the countdown will be paused. Push **Resume**  to resume the countdown.

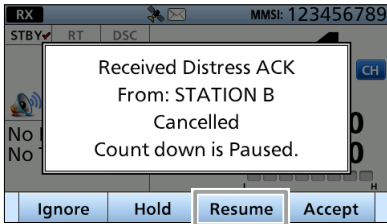

◇ Receiving a Distress Relay call

When a Distress Relay call is received:

- The emergency alarm sounds until you turn it OFF.
 - “Received Distress Relay” is displayed.
1. Push **Alarm Off**  to turn OFF the alarm.





① When “Accept after 10 sec.” or “Ignore after 10 sec.” is selected in “CH Auto Switch” setting, the countdown is displayed on the bottom of the window. (p. 58)

After 10 seconds have passed since **Alarm Off**  is pushed, the screen will move to the DSC Task screen, or return to the Main screen.

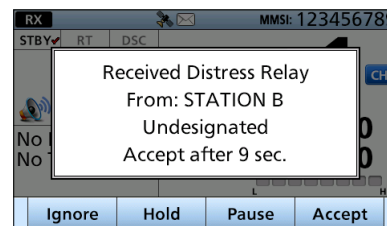
2. Push the Software Key below the intended operation.



Ignore : Ignores the call and returns to the Main screen.

Hold : Puts the RX task on hold, and returns to the Main screen.

Pause : Pauses the countdown.

Accept : Enters the DSC Task mode immediately.

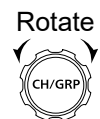
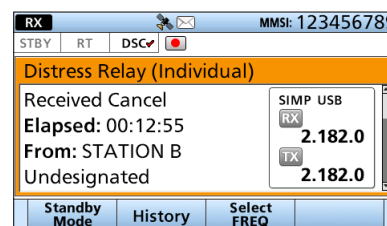

- One of the Emergency Frequencies is automatically selected. Monitor it because a coast station may require assistance.
 - Rotate [CH/GRP] to confirm the call contents.
- ① See pages 27 and 28 for details of the Software Key functions in the DSC Task mode.

3. Push **Standby Mode** [OK], and then **OK** to return to the Main screen.

TIP: When you push **Pause** in step 2, the countdown will be paused. Push **Resume** to resume the countdown.



◇ Receiving a Distress Relay Acknowledgment

When a Distress Relay Acknowledgment is received:

- The emergency alarm sounds until you turn it OFF.
 - “Received Distress Relay ACK” is displayed.
1. Push **Alarm Off** to turn OFF the alarm.

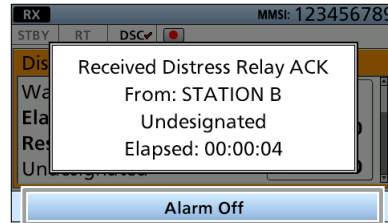

2. Push **Close Call RCVD Window**.

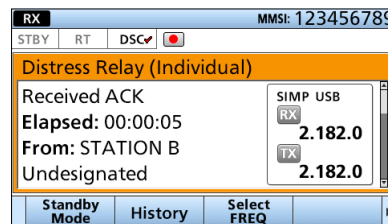
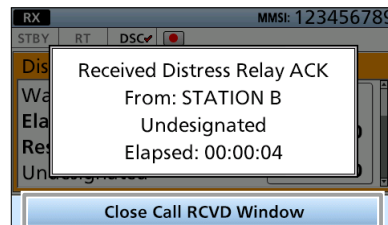

- One of the Emergency Frequencies is automatically selected. Monitor it, because a coast station may require assistance.
 - Rotate [CH/GRP] to confirm the call contents.
- ① See pages 27 and 28 for details of the Software Key functions in the DSC Task mode.
3. Push **Standby Mode** [OK], and then **OK** to return to the Main screen.

Receiving DSC calls (other)

Receiving an Individual call

NOTE:

- When the “Individual ACK” is set to “Auto (Able)” or “Auto (Unable),” the transceiver automatically sends an Acknowledgment “Able to comply” or “Unable to comply.” (p. 57)
In that case, both the TX and RX calls are stored in the Transmitted and Received Call Logs. (p. 54)
- To receive an Individual call, push [D-SCAN] to enter the DSC watch mode. (p. 13)

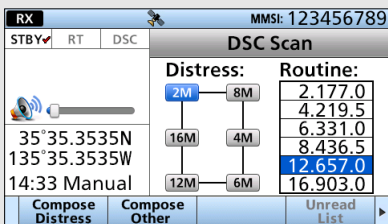

When an Individual call is received:

- The alarm sounds until you turn it OFF.
 - “Received Individual Call” is displayed.
- Push **Alarm Off** to turn OFF the alarm.

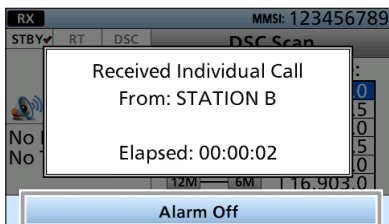

- Push the Software Key below the intended operation.

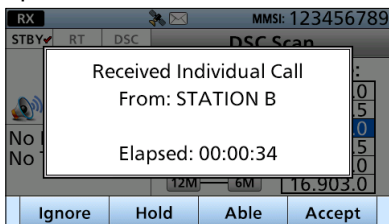

- Ignore**: Ignores the call and returns to the Main screen.
- Hold**: Puts the RX task on hold, and returns to the Main screen.
- Able**: Sends an Acknowledgment “Able to comply” without any changes.
- Accept**: Enters the DSC Task mode immediately.

NOTE: When you select **Accept** in this step, you can send an Acknowledgment in the DSC Task mode. To send the Acknowledgment, go to step 3. If you return to the Main screen without sending the Acknowledgment, go to step 7.

- Push a key to select an Acknowledgment option.
 - The Call Contents screen is displayed

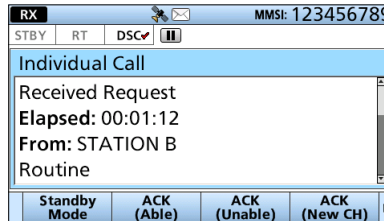

- Confirm the contents.

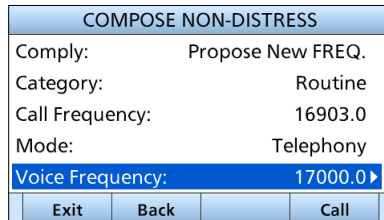

- Push **Call** to send an Individual Acknowledgment.
- Hold down [PTT] to talk.
- Push **Standby Mode**, and then **OK** to return to the Main screen.

TIP: When you send the Acknowledgment, select one of three options, depending on your situation. See pages 36 and 37 for details of the Individual Acknowledgment procedures.

◇ Receiving an Individual Acknowledgment

When receiving “ACK (Able)”:

You can communicate on the frequency that you specified when sending the call.

- When “ACK (Able)” is received:
 - The emergency alarm sounds until you turn it OFF.
 - “Received Individual ACK” is displayed.
 Push **Alarm Off** to turn OFF the alarm.

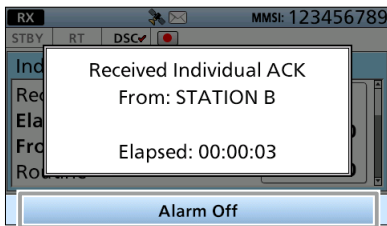

- Push **Close Call RCVD Window**.

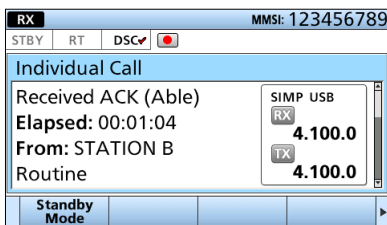
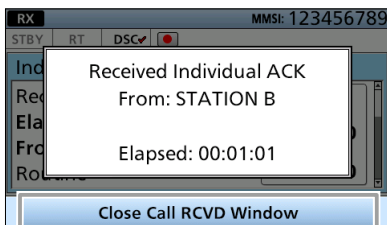

- The Voice frequency that you specified when sending the call is automatically selected.
 - Rotate [CH/GRP] to confirm the call contents.
- Hold down [PTT], and then explain your situation.
 - After you have finished your conversation, push **Standby Mode**, and then **OK** to return to the Main screen.

When receiving “ACK (Unable)”:

You cannot communicate further.

- When “ACK (Unable)” is received:
 - The emergency alarm sounds until you turn it OFF.
 - “Received Individual ACK” is displayed.
 Push **Alarm Off** to turn OFF the alarm.

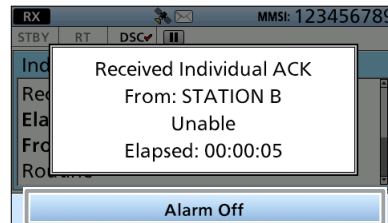

- Push **Close Call RCVD Window**.

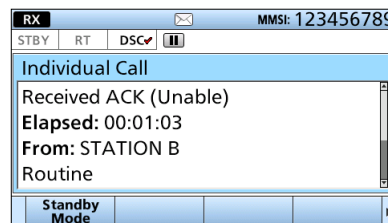
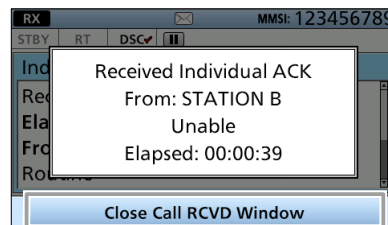

- Rotate [CH/GRP] to confirm the call contents.
- ① See pages 27 and 28 for details of the Software Key functions in the DSC Task mode.
- Push **Standby Mode**, and then **OK** to return to the Main screen.

7 DSC OPERATION

■ Receiving DSC calls (other)

◇ Receiving an Individual Acknowledgment (continued)

When receiving "ACK (New CH)":

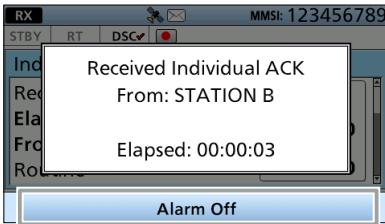

You can communicate on the frequency that the called station proposed.

- When "ACK (New CH)" is received:
 - The emergency alarm sounds until you turn it OFF.
 - "Received Individual ACK" is displayed.
 Push **Alarm Off**  to turn OFF the alarm.

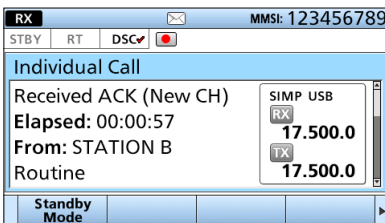
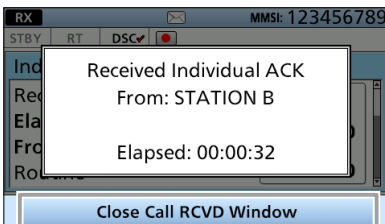

- Push **Close Call RCVD Window** .





- The Voice frequency that the called station specified is automatically selected.
 - Rotate [CH/GRP] to confirm the call contents.
- Hold down [PTT], and then explain your situation.
 - After you have finished your conversation, push **Standby Mode** , and then **OK**  to return to the Main screen.

◇ Receiving a Group call

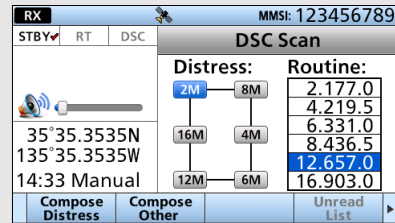
NOTE: To receive an Group call, push [D-SCAN] to enter the DSC watch mode. (p. 13)





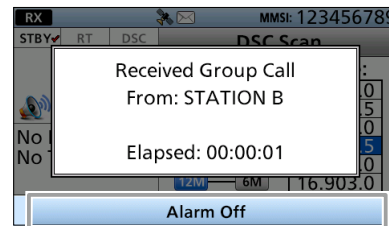

When a Group call is received:

- The emergency alarm sounds until you turn it OFF.
 - "Received Group Call" is displayed.
- Push **Alarm Off**  to turn OFF the alarm.
 - When "Accept after 10 sec." or "Ignore after 10 sec." is selected in "CH Auto Switch" setting, the countdown is displayed on the bottom of the window. (p. 58)
After 10 seconds have passed since **Alarm Off**  is pushed, the screen will move to the DSC Task screen, or return to the Main screen.

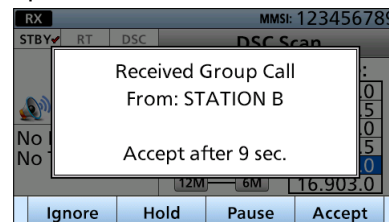

- Push the Software Key below the intended operation.



- Ignore** : Ignores the call and returns to the Main screen.
- Hold** : Puts the RX task on hold, and returns to the Main screen.
- Pause** : Pauses the countdown.
- Accept** : Enters the DSC Task mode immediately.

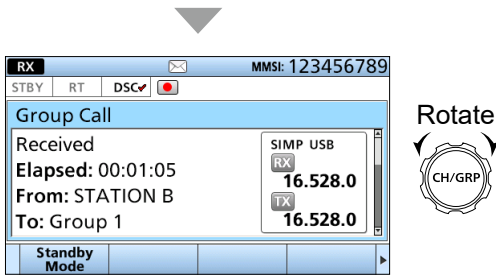

- Monitor the Voice frequency that the calling station specified.
 - ① Rotate [CH/GRP] to confirm the call contents.
 - ① See pages 27 and 28 for details of the Software Key functions in the DSC Task mode.
3. Push **Standby Mode** [key], and then **OK** [key] to return to the Main screen.

TIP: When you push **Pause** [key] in step 2, the countdown will be paused. Push **Resume** [key] to resume the countdown.

◇ Receiving a Geographical Area call

When a Geographical Area call is received:

- The emergency alarm sounds until you turn it OFF.
 - “Received Geographical” is displayed.
1. Push **Alarm Off** [key] to turn OFF the alarm.



- ① When “Accept after 10 sec.” or “Ignore after 10 sec.” is selected in “CH Auto Switch” setting, the countdown is displayed on the bottom of the window. (p. 58)
After 10 seconds have passed since **Alarm Off** [key] is pushed, the screen will move to the DSC Task screen, or return to the Main screen.

2. Push the Software Key below the intended operation.

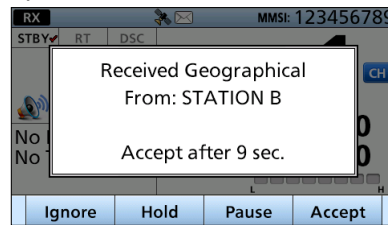

- Ignore** [key]: Ignores the call and returns to the Main screen.
- Hold** [key]: Puts the RX task on hold, and returns to the Main screen.
- Pause** [key]: Pauses the countdown.
- Accept** [key]: Enters the DSC Task mode immediately.

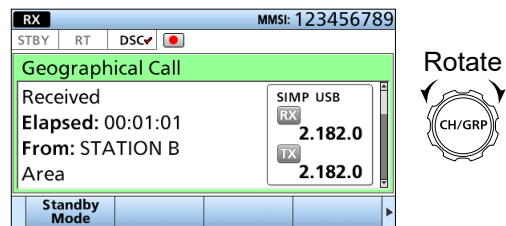



- Monitor the Voice frequency that the calling station specified.
- ① Rotate [CH/GRP] to confirm the call contents.
- ① See pages 27 and 28 for details of the Software Key functions in the DSC Task mode.



► Continued on the next page

7 DSC OPERATION

■ Receiving DSC calls (other)

◇ Receiving a Geographical Area call (continued)

3. Push **Standby Mode** , and then **OK**  to return to the Main screen.

TIP: When you push **Pause**  in step 2, the countdown will be paused. Push **Resume**  to resume the countdown.

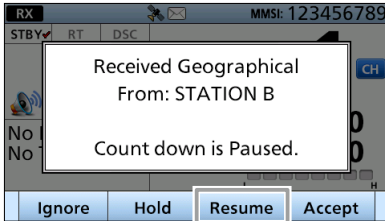

◇ Receiving a Test call

NOTE: When the “Test ACK” is set to “Auto,” the transceiver automatically sends an Acknowledgment. (p. 57)

In that case, both the TX and RX calls are stored in the Transmitted and Received Call Logs.

When a Test call is received:

- The alarm sounds until you turn it OFF.
 - “Received Test Call” is displayed.
1. Push **Alarm Off**  to turn OFF the alarm.

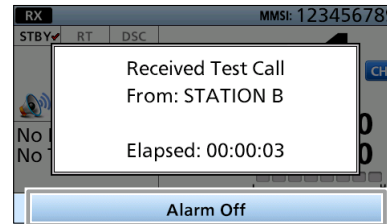

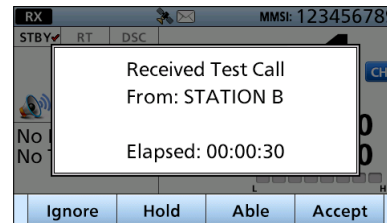

2. Push the Software Key below the intended operation.



Ignore : Ignores the call and returns to the Main screen.

Hold : Puts the RX task on hold, and returns to the Main screen.

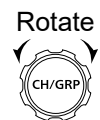
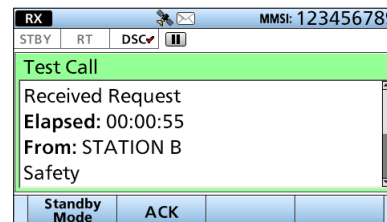

Able : Sends an Acknowledgment “Able to comply.”

Unable : Sends an Acknowledgment “Unable to comply.”



① Rotate [CH/GRP] to confirm the call contents.

① See pages 27 and 28 for details of the Software Key functions in the DSC Task mode.

3. Push **Standby Mode** , and then **OK**  to return to the Main screen.

TIP: See page 43 for details on sending an Acknowledgment.

◇ Receiving a Test Acknowledgment

When a Test Acknowledgment is received:

- The alarm sounds until you turn it OFF.
 - “Received Test ACK” is displayed.
1. Push **Alarm Off**  to turn OFF the alarm.

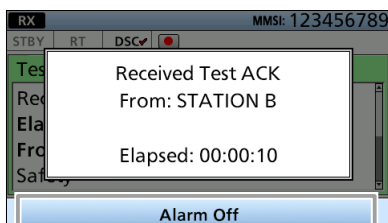

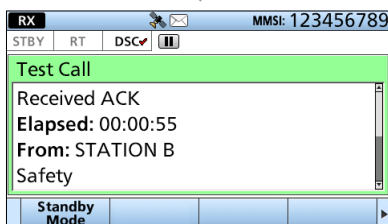
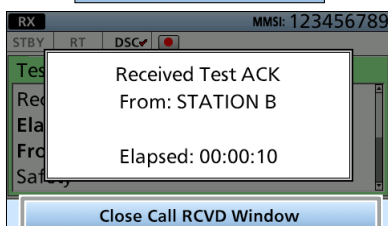

2. Push **Close Call RCVD Window** .



Rotate







- ① Rotate [CH/GRP] to confirm the call contents.
- ① See pages 27 and 28 for details of the Software Key functions in the DSC Task mode.

3. Push **Standby Mode** , and then **OK**  to return to the Main screen.

■ DSC Log

NOTE:

- On the Main screen,  is displayed when there is an unread DSC message.
- On the Main screen,  blinks when a new DSC message is received.
- On the Main screen, no icon is displayed when there are no DSC message.
- The Distress messages are stored in “Distress.”
-  is displayed for an unread DSC message in the DSC Log screen.
-  is displayed for a DSC message already read in the DSC Log screen.

◇ Received DSC Log

The transceiver saves up to 50 received Distress call messages and 50 received “Others” call messages in your DSC Log.

1. Push **DSC Log** .
 - The “Received Call Log” screen is displayed.
 - ① To display the screen from the Menu screen:
[MENU] > DSC Log > Received Call Log

2. Select “Distress” or “Others.”

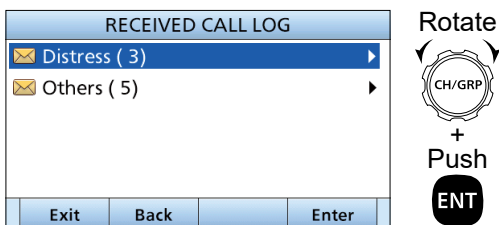

① “Distress” displays the received Distress call log, and “Others” displays the received DSC call log.

3. Select a log to display the detailed information.

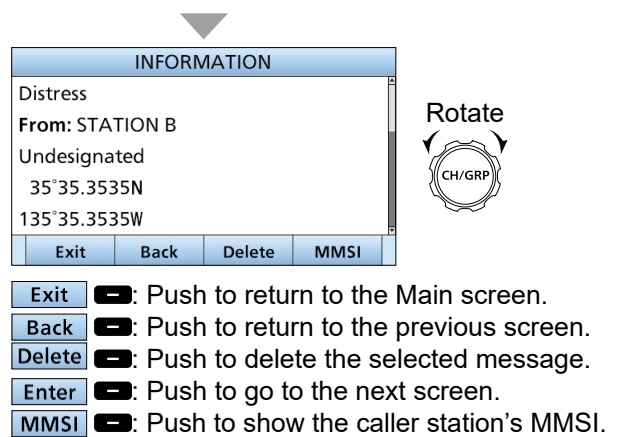
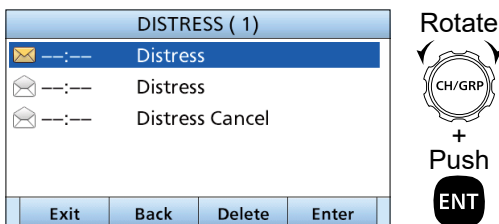



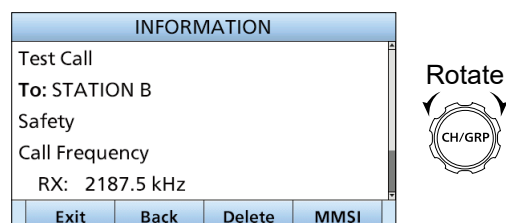
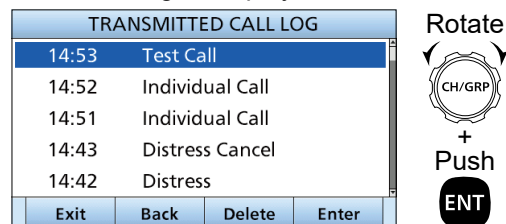

◇ Transmitted DSC Log

The transceiver saves up to 50 DSC transmitted calls in your DSC log.

1. Open “Transmitted Call Log.”
[MENU] > DSC Log > Transmitted Call Log
2. Select the log to display the detailed information.



- Exit** : Push to return to the Main screen.
- Back** : Push to return to the previous screen.
- Delete** : Push to delete the selected message.
- Enter** : Push to go to the next screen.
- MMSI** : Push to show the destination station’s MMSI.

■ DSC Settings

- ◇ Position Input (p. 26)
- ◇ Individual ID (p. 24)
- ◇ Group ID (p. 24)

◇ DSC Frequency

This set frequencies are selectable when you want to send an Individual call, Group call, and Geographical Area call. Usually your dealer has set all the DSC frequencies to use.

To add a new DSC frequency:

1. Open "DSC Frequency."

[MENU] > DSC Settings > DSC Frequency

2. Select a DSC frequency number.

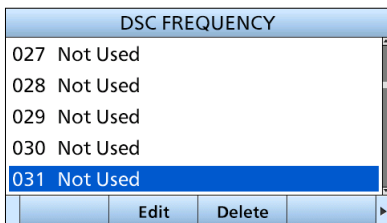

3. Select "Use."

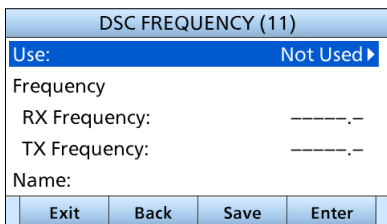

4. Select an option.

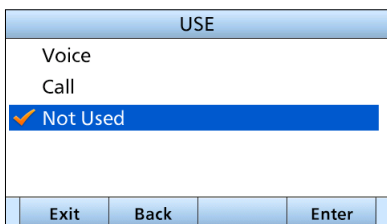

5. Select "Frequency."

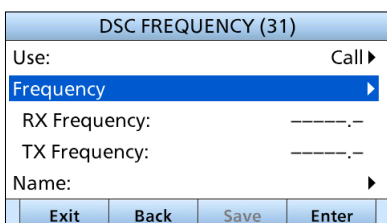

6. Enter a receive frequency, and then push **Finish**.

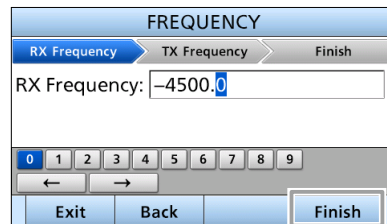

7. Enter a transmit frequency, and then push **Finish**.

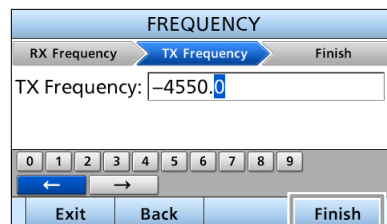

8. Select "Name."

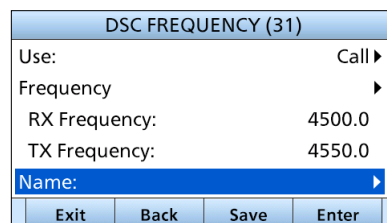

9. Enter a DSC frequency name, and then push **Finish**.

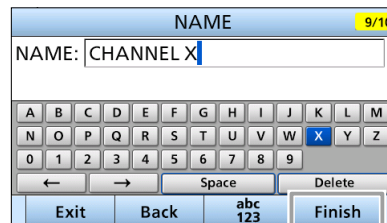

10. Push **Save**.

- "Are You Sure?" is displayed.

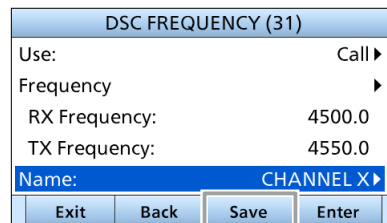

7 DSC OPERATION

■ DSC Settings

◇ DSC Frequency (continued)

- Push **OK**  to save the ID.
 - The entered name is displayed.

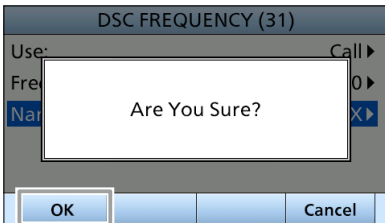

- Push **[MENU]** to return to the Main screen.

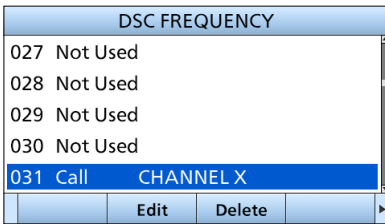

◇ Scanning Receiver

You can turn the Scanning Receiver function ON or OFF on each Emergency Frequency.

When selecting “Distress frequency”

NOTE: You cannot turn OFF the function on 2187.5 kHz and 8414.5 kHz, and 1 of the remaining 4 frequencies.

- Open “Distress.”

[MENU] > DSC Settings > Scanning Receiver > Distress

- Select a frequency.

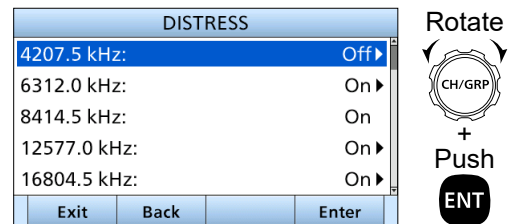

- Select an option.

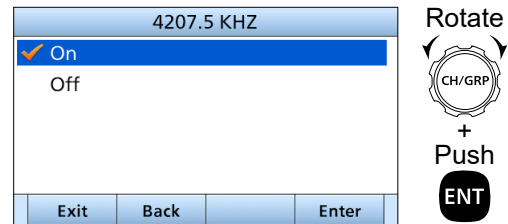

- On: The Emergency frequency is scanned during the Distress scan.
- Off: The Emergency frequency is skipped during the Distress scan.

- Push **[MENU]**, or **Exit**  to return to the Main screen.

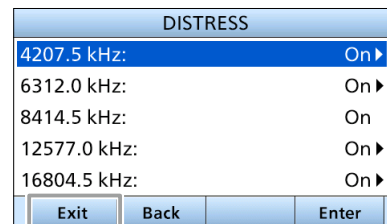

When selecting or editing “Routine frequency”

1. Open “Routine.”

[MENU] > DSC Settings > Scanning Receiver > **Routine**

2. Select a channel.

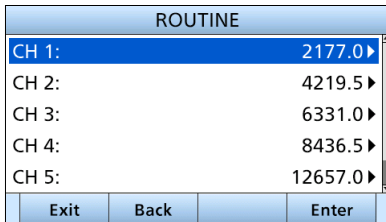

3. Enter a Routine frequency, and then push

Finish

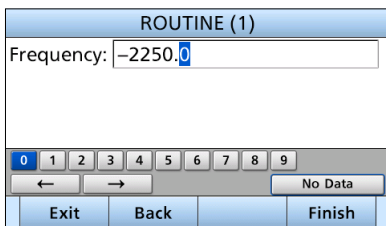

4. Push [MENU], or **Exit** to return to the Main screen.

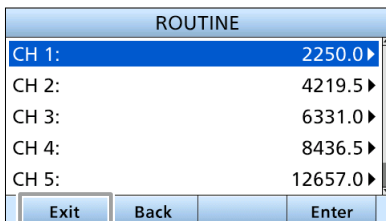

◇ Auto ACK

The Auto ACK function automatically sends an Acknowledgment when an appropriate request is received.

1. Open “Auto ACK.”

[MENU] > DSC Settings > **Auto ACK**

2. Select an item.

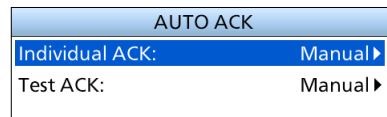

3. Select an option.

● **Individual ACK**

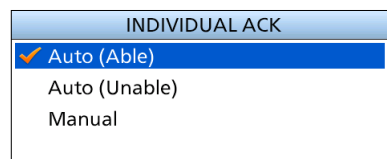

- Auto (Able): Automatically sends “Able to comply.”
- Auto (Unable): Automatically sends “Unable to comply.”
- Manual: Manually sends an Acknowledgment.

● **Test ACK**

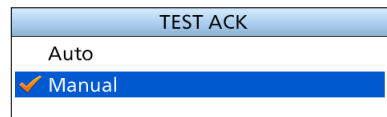

- Auto (Able): Automatically sends an Acknowledgment.
- Manual: Manually sends an Acknowledgment.

4. Push [MENU], or **Exit** to return to the Main screen.

■ DSC Settings

◇ CH Auto Switch



By regulation, after receiving a DSC call, the transceiver automatically switches the operating channel to the displayed frequency. However, when you set this function to "OFF", the transceiver remains on the operating channel, even after receiving a DSC call.

1. Open "CH Auto Switch."

[MENU] > DSC Settings > **CH Auto Switch**

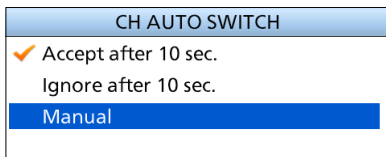
2. Select an option.



- **Accept after 10 sec.:**
After receiving a DSC call, the transceiver remains on the current operating channel for 10 seconds. After that, the transceiver automatically switches to the displayed frequency.
 - **Ignore after 10 sec.:**
After receiving a DSC call, if you do not push **Accept**  in 10 seconds, the transceiver ignores the call, and then remains on the current operating channel.
 - **Manual:**
After receiving a DSC call, you can select whether or not to accept the received DSC call.
3. Push [MENU], or **Exit**  to return to the Main screen.

◇ NMEA Data Output

When receiving a DSC call from the station that is selected in this setting, the transceiver outputs the DSC data to the NMEA output port.

① You can send Distress calls despite this setting.

1. Open "NMEA Data Output."

[MENU] > DSC Settings > **NMEA Data Output**

2. Select an option.

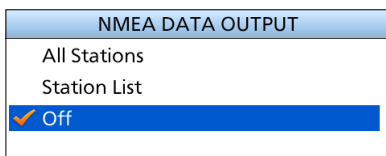

- **All stations:** From any station.
- **Station List:** From the stations that are entered in Individual ID or Group ID on the Menu screen.
- **Off:** Does not output any DSC data from the NMEA 0183 Output port.

◇ Alarm Status

Sets the alarm ON or OFF when receiving each type of DSC call.

Safety/Routine

Select whether or not to sound an alarm when receiving the Safety or Routine DSC call.

1. Open "Alarm Status."

[MENU] > DSC Settings > **Alarm Status**

2. Select "Safety" or "Routine."

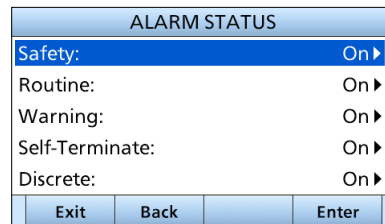

3. Select an option.

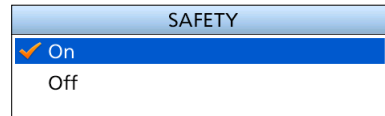

- **On:** Alarm sounds.
- **Off:** Alarm does not sound.

4. Push [MENU], or **Exit**  to return to the Main screen.

Warning

Select whether or not to sound an alarm for when:

- No MMSI is entered.
- The received position data has not been updated for 10 minutes.
- The position data has not been manually updated for 4 hours.
- The received, or manually entered position data has not been updated for 23.5 hours.

1. Open "Alarm Status."

[MENU] > DSC Settings > **Alarm Status**

2. Select "Warning."

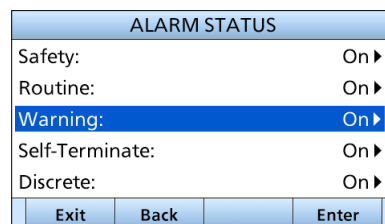

3. Select an option.

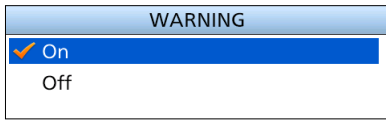

- On: Alarm sounds.
- Off: Alarm does not sound.

4. Push [MENU], or **Exit** to return to the Main screen.

Self-Terminate

Select whether or not to sound an alarm when receiving the same Distress call.

1. Open "Alarm Status."

[MENU] > DSC Settings > **Alarm Status**

2. Select "Self-Terminate."

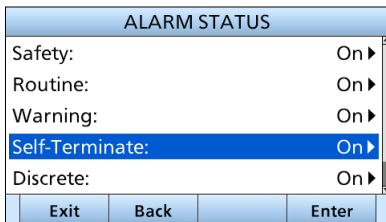

3. Select an option.

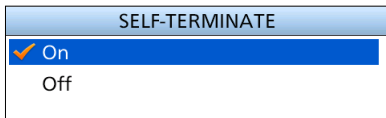

- On: Alarm sounds.
- Off: Alarm does not sound.

4. Push [MENU], or **Exit** to return to the Main screen.

Discrete

Select whether or not to sound an alarm when receiving a lower priority DSC call while currently receiving a higher priority call.

1. Open "Alarm Status."

[MENU] > DSC Settings > **Alarm Status**

2. Select "Discrete."

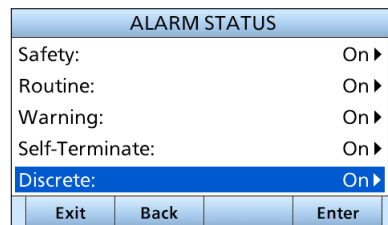

3. Select an option.

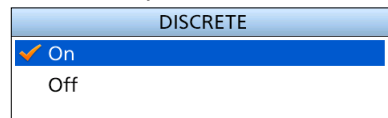

- On: Alarm sounds.
- Off: Alarm does not sound.

4. Push [MENU], or **Exit** to return to the Main screen.

MAX Distance 2-Tone

Set the max distance between vessels for the ringing of the 2-tone alarm is enabled.

1. Open "Alarm Status."

[MENU] > DSC Settings > **Alarm Status**

2. Select "MAX Distance 2-Tone."

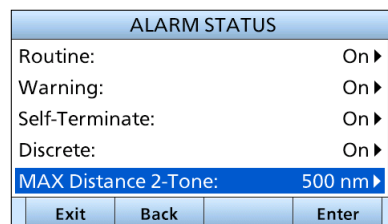

3. Enter the max distance.

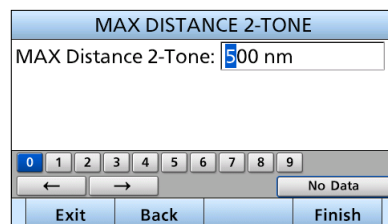

4. Push [MENU], or **Exit** to return to the Main screen.

■ DSC Settings

◇ Self Check Test

The Self Check test sends DSC signals to the receiving AF circuit to compare the sending and receiving signals at the AF level.

1. Open “Self Check Test.”

[MENU] > DSC Settings > **Self Check Test**

2. Push [ENT], or **Enter**  to start the Self Check Test.

① When the sending and receiving DSC signals match, “OK” is displayed.

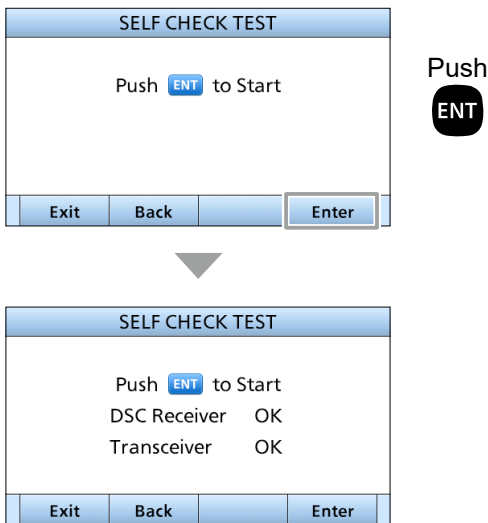

◇ Procedure

You can select the type of task for the transceiver, depending on the presetting.

1. Open “Procedure.”

[MENU] > DSC Settings > **Procedure**

2. Select an option.

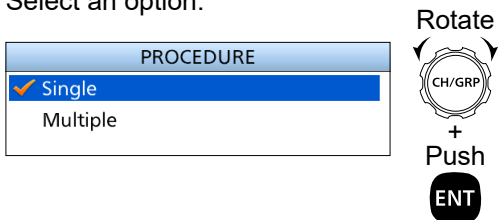

- Single: Handles only 1 task at the same time.
- Multiple: Handles up to 7 tasks at the same time.

■ Menu items

The Menu screen is constructed in a tree structure. (p.10)

NOTE: See page 11 about how to select each Menu item.

The following items are described in each section. Refer to the pages in parenthesis for details.

① The displayed menu items may differ, depending on the transceiver version or presetting.

◇ Compose Distress (p. 29)

◇ Compose Non-Distress

- Individual calls (p. 35)
- Group calls (p. 37)
- Geographical Area calls (p. 39)
- Test calls (p. 42)

◇ GPS Information (p. 62)

◇ Configuration

Item		Reference
Display	Backlight	p. 62
	Mode	p. 62
	Night Mode Time	p. 62
Key Beep	—	p. 62
Key Assignment	—	p. 62
MIC Key Lock	—	p. 62
UTC Offset	—	p. 62
Inactivity Timer	Not DSC Related	p. 63
	DSC Related	p. 63
	RT Related: USB/AM/LSB/AFSK/ FSK/CW/e-mail	p. 63
GPS	Internal GPS	p. 63
	External GPS	p. 64
	NMEA Data Output	p. 64
Remote	Interface	p. 64
	MOD	p. 64
	Baud Rate	p. 64

◇ DSC Log (p. 54)

◇ DSC Settings (p. 55)

◇ Radio Settings

Item		Reference
User CH	—	p. 21
MAX User CH	—	p. 65
e-mail CH	—	p. 21
ITU Simplex CH	—	p. 21
Auto Tune	—	p. 65
External Tuner	—	p. 65
Noise Reduction	—	p. 65
Scan	Type	p. 65
	Speed	p. 65
	Program Scan FREQ	p. 66
Voice Scrambler Code	—	p. 66
Voice SQL	—	p. 66
IF Filter	AFSK Filter	p. 66
	FSK Filter	p. 66
FSK	ITU FSK CH	p. 66
	Mark Frequency	p. 66
	Shift Frequency	p. 67
	Polarity	p. 67
CW break-in	—	p. 67
Instant Replay	Function	p. 67
	Recording Time	p. 67
	Play Time	p. 67

◇ Radio Information (p. 67)

■ GPS Information

Displays the data received by the external GPS receiver.

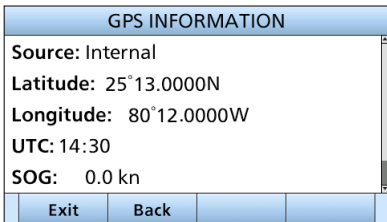

■ Configuration

◇ Displays

● Backlight

[MENU] > Configuration > Displays > **Backlight**

Set the brightness of the backlight.

Day mode

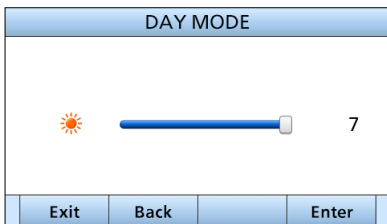

Night mode

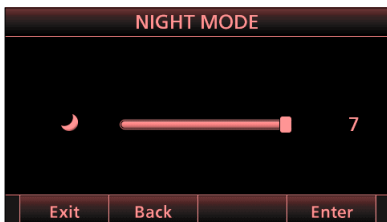

● Mode

[MENU] > Configuration > Display > **Mode**

Set the LCD backlight mode.

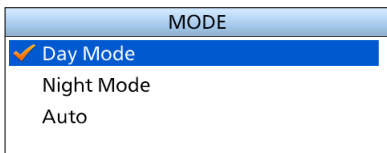

- Day mode: The screen is displayed in the Day mode.
- Night mode: The screen is displayed in the Night mode.
- Auto: The Day mode or the Night mode is automatically selected.

● Night Mode Time

[MENU] > Configuration > Display > **Night Mode Time**

Set the start time and end time of Night mode.

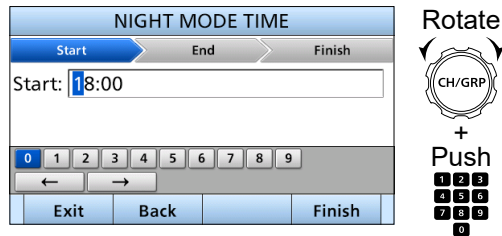

◇ Key Beep

[MENU] > Configuration > **Key Beep**

Turn the Key Beep function ON or OFF.

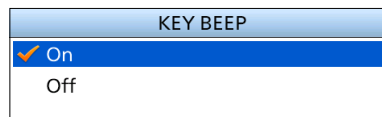

- On: When you push a key, a beep sounds.
- Off: Turns OFF the function for silent operation.

◇ Key Assignment

[MENU] > Configuration > **Key Assignment**

You can assign some functions to the software keys to create convenient shortcuts. See pages 22 and 23 about how to assign.

◇ MIC Key Lock

[MENU] > Configuration > **MIC Key Lock**

Turn the MIC key Lock function ON or OFF.

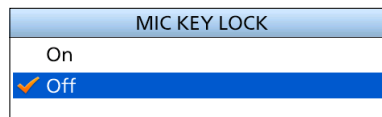

- On: Key lock is ON.
- Off: Key lock is OFF.

◇ UTC Offset

[MENU] > Configuration > **UTC Offset**

Set the offset time between UTC (Universal Time Coordinated) and your local time to between -14:00 and +14:00 (in 1 minute steps).

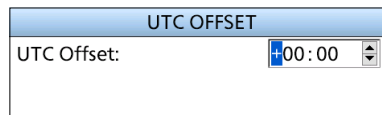

◇ Inactivity Timer

[MENU] > Configuration > **Inactivity Timer**

The transceiver automatically returns to the Main screen if you push no key for the set period time for each mode.

The count down alarm sounds 10 seconds before the Inactivity Timer activates.

INACTIVITY TIMER	
Not DSC Related:	10 min ▶
DSC Related:	15 min ▶
Distress Related:	Off ▶
RT Related-USB:	30 sec ▶
RT Related-AM:	30 sec ▶
Exit Back Enter	

For Not DSC Related, DSC Related, and Distress Related:

Set the Inactivity Timer to between 1 and 15 minutes (in 1 minute steps), or OFF.

NOT DSC RELATED	
Off	
1 min	
2 min	
3 min	
4 min	
Exit Back Enter	

● Not DSC Related

[MENU] > Configuration > Inactivity Timer > **Not DSC Related**

Setting for when a screen that is not related to DSC is displayed.

● DSC Related

[MENU] > Configuration > Inactivity Timer > **DSC Related**

Setting for when a screen that is related to DSC is displayed.

● Distress Related

[MENU] > Configuration > Inactivity Timer > **Distress Related**

Setting for when a screen that is related to a Distress call is displayed.

For RT Related:

Set the Inactivity timer to 10 sec, 30 sec, or between 1 and 10 min (in 1 minute steps).

RT RELATED-USB	
10 sec	
30 sec	✓
1 min	
2 min	
3 min	
Exit Back Enter	

● RT Related-USB/AM/LSB/AFSK/FSK/CW/e-mail

[MENU] > Configuration > Inactivity Timer > **RT Related-USB/AM/LSB/AFSK/FSK/CW/e-mail**

Setting for when the transceiver is in the Radio Telephone mode.

◇ GPS

● Internal GPS

[MENU] > Configuration > GPS > **Internal GPS**

Selects a satellite to be used for GPS (Global Positioning System) to pinpoint the geographic location of your transceiver anywhere in the world. This setting may not be usable, depending on the transceiver version or presetting.

INTERNAL GPS	
GPS:	On
GLONASS:	On ▶
SBAS:	Off ▶
Exit Back Enter	

● GPS

The GPS (Global Positioning System) is permanently set to ON.

● GLONASS

Selects whether or not to use the data from the GLONASS (GLObal'naya NAVigatsionnaya Sputnikovaya Sistema) satellites.

● SBAS

Turns the SBAS (Satellite Based Augmentation System) function ON or OFF. When turning ON this function, the GPS position accuracy can be improved.

■ Configuration

◇ GPS (continued)

● External GPS

[MENU] > Configuration > GPS > **External GPS**

Select the data transfer speed to receive data from an external GPS receiver from 4800, 9600, 19200, 38400 bps.

EXTERNAL GPS		
Baud Rate:	4800 bps ▶	
Exit	Back	Enter



BAUD RATE		
✓ 4800 bps		
9600 bps		
19200 bps		
38400 bps		
Exit	Back	Enter

● NMEA Data Output

[MENU] > Configuration > GPS > **NMEA Data Output**

Select whether or not to output the position data from the NMEA 0183 output port.

NMEA DATA OUTPUT	
On	
✓ Off	

- On: Outputs the position data from the NMEA output.
- Off: Does not output the position data.

◇ Remote

● Interface

[MENU] > Configuration > Remote > **Interface**

Select the interface format for the remote connector from NMEA or RS-232C.

INTERFACE	
✓ NMEA	
RS-232C	

● MOD

[MENU] > Configuration > Remote > **MOD**

Select the input/output terminal for connecting to/ from an external unit from MIC, ACC, or AF/MOD.

MOD	
MIC	
ACC	
✓ AF/MOD	

● Baud Rate

[MENU] > Configuration > Remote > **Baud Rate**

Select the data transfer speed to receive data from an external controller such as a PC, from 4800, 9600, 19200, 38400 bps.

BAUD RATE		
✓ 4800 bps		
9600 bps		
19200 bps		
38400 bps		
Exit	Back	Enter

■ Radio Settings

- ◇ User CH (p. 21)
- ◇ e-mail CH (p. 21)
- ◇ ITU Simplex CH (p. 21)

◇ Max User CH

[MENU] > Radio Settings > **Max User CH**

Set the number of maximum User channels to between 1 and 160.

MAX USER CH	
CH:	160

◇ Auto Tune

[MENU] > Radio Settings > **Auto Tune**

Turn the Auto Tune function ON or OFF. When this function is ON, tuning is automatically started at that frequency when [PTT] is pushed.

AUTO TUNE	
On	
<input checked="" type="checkbox"/> Off	

- On: When [PTT] is pushed, tuning is automatically started at that frequency.
- Off: When the operating frequency is changed, tuning is needed by pushing [TUNE] (p. 4).

◇ External Tuner

[MENU] > Radio Settings > **External Tuner**

Select AT-140, AT-130, AT-120, or AH-3 external tuner.

EXTERNAL TUNER	
<input checked="" type="checkbox"/> AT-140	
AT-130	
AT-120	
AH-3	

◇ Noise Reduction

[MENU] > Radio Settings > **Noise Reduction**

Set the Noise Reduction level to between 1 and 10, or OFF.

NOISE REDUCTION	
<input checked="" type="checkbox"/> Off	
1	
2	
3	
4	

◇ Scan

● Type

[MENU] > Radio Settings > Scan > **Type**

Select a Scan type to locate signals.
① See pages 16 and 17 for details.

TYPE	
<input checked="" type="checkbox"/> CH	
CH Resume	
Program	

- CH/CH Resume: The CH and CH Resume searches within a 20 channel range, such as channel 1 to channel 20, in the user channels, and searches all channels in the same bandwidth in the group of ITU channels and ITU FSK channels.
- Program: The Program scan searches the selected channel within the frequency range set by the "Start frequency" setting and the "End frequency" setting.

● Speed

[MENU] > Radio Settings > Scan > **Speed**

Set the scanning speed (the rate at which channels are searched) to between 1 (fast) and 10 (slow).

SPEED	
1 (Fast)	
2	
3	
<input checked="" type="checkbox"/> 4	
5	

■ Radio Settings

◇ Scan (continued)

● Program Scan FREQ

[MENU] > Radio Settings > Scan > **Program Scan FREQ**

Set the Start Frequency and the End Frequency used for the Program scan.

PROGRAM SCAN FREQ	
Start Frequency:	1.600.0 ▶
End Frequency:	29.999.9 ▶

START FREQUENCY																					
Start Frequency:	1.600.0																				
<table border="1"> <tr> <td>0</td><td>1</td><td>2</td><td>3</td><td>4</td><td>5</td><td>6</td><td>7</td><td>8</td><td>9</td> </tr> <tr> <td colspan="2">←</td> <td colspan="2">→</td> <td colspan="6"></td> </tr> </table>		0	1	2	3	4	5	6	7	8	9	←		→							
0	1	2	3	4	5	6	7	8	9												
←		→																			
Exit	Back	Finish																			



◇ Voice Scrambler Code

[MENU] > Radio Settings > **Voice Scrambler Code**

Set the Voice Scrambler Code to use the Voice Scrambler function.

VOICE SCRAMBLER CODE																					
Voice Scrambler Code:	000																				
<table border="1"> <tr> <td>0</td><td>1</td><td>2</td><td>3</td><td>4</td><td>5</td><td>6</td><td>7</td><td>8</td><td>9</td> </tr> <tr> <td colspan="2">←</td> <td colspan="2">→</td> <td colspan="6"></td> </tr> </table>		0	1	2	3	4	5	6	7	8	9	←		→							
0	1	2	3	4	5	6	7	8	9												
←		→																			
Exit	Back	Finish																			



◇ Voice SQL

[MENU] > Radio Settings > **Voice SQL**

Turn the Voice Squelch function ON or OFF for operating in the USB or AM mode.

VOICE SQL	
<input checked="" type="checkbox"/> On	
<input type="checkbox"/> Off	

- On: Outputs the position data from the NMEA output.
- Off: Does not output the position data.

◇ IF Filter

[MENU] > Radio Settings > **IF Filter**

Select the IF Filter passband width for the AFSK and FSK mode operation from Wide, Middle, and Narrow.

IF FILTER	
AFSK Filter:	Narrow ▶
FSK Filter:	Narrow ▶



AFSK FILTER	
<input type="checkbox"/> Wide	
<input type="checkbox"/> Middle	
<input checked="" type="checkbox"/> Narrow	

◇ FSK

● ITU FSK CH

[MENU] > Radio Settings > FSK > **ITU FSK CH**

Select whether or not to use ITU FSK channels.

ITU FSK CH	
<input type="checkbox"/> On	
<input checked="" type="checkbox"/> Off	

- On: The channels can be used.
- Off: The channels cannot be used.

● Mark Frequency

[MENU] > Radio Settings > FSK > **Mark Frequency**

Set the FSK mark frequency for the FSK operation from 1200, 1275, 1487.5, 1615, 2100, and 2125 kHz.

MARK FREQUENCY		
1200 Hz		
1275 Hz		
1487.5 Hz		
<input checked="" type="checkbox"/> 1615 Hz		
2100 Hz		
Exit	Back	Enter

● **Shift Frequency**

[MENU] > Radio Settings > FSK > **Shift Frequency**

Set the FSK shift frequency for the FSK operation from 170, 200, 425, and 850 kHz.

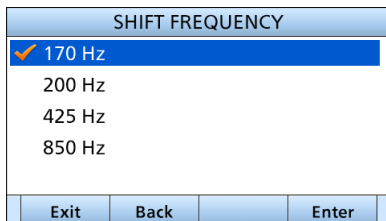

● **Polarity**

[MENU] > Radio Settings > FSK > **Polarity**

Select FSK polarity.

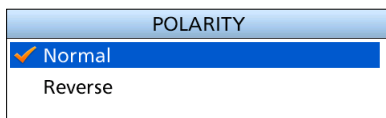

- Normal: Key open = space
Key close = mark
- Reverse: Key open = mark
Key close = space

◇ **CW break-in**

[MENU] > Radio Settings > **CW break-in**

Set the CW break-in function. This function enables more comfortable CW operation by automatically switching transmitting and receiving.

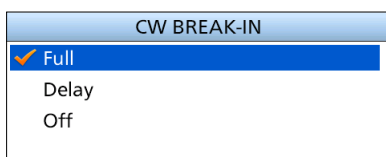

- Full: Transmitting when the key is pressed, and return to receiving immediately after releasing the key.
- Delay: Transmitting when the key is pressed, and return to receiving when 0.5 seconds have passed since the key is released.
- Off: Does not switch transmitting and receiving even though the key is pressed.

◇ **Instant Replay**

● **Function**

[MENU] > Radio Settings > Instant Replay > **Function**

Turn the Instant Replay function ON or OFF. This function enables you to record the received audio data, and replay it.

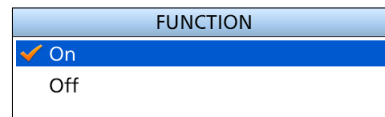

- On: The function is ON.
- Off: The function is OFF.

● **Recording Time**

[MENU] > Radio Settings > Instant Replay > **Recording Time**

The maximum recordable time is permanently set to 120 seconds.

● **Play Time**

[MENU] > Radio Settings > Instant Replay > **Play Time**

Set the playback start position of the recorded audio data to between 5 and 120 seconds (in 5 second steps). When **RX Play** is pushed, playback will start from the position rewound for the set time from the end of the recording time.



■ **Radio Information**

Displays your transceivers information as shown below.

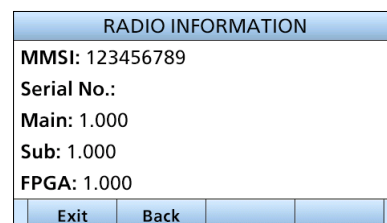

■ Supplied accessories

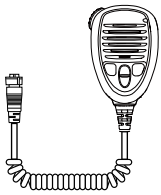

Microphone

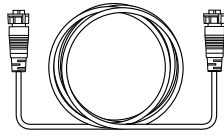

Remote control cable
(5.1 m, 16.7 ft)

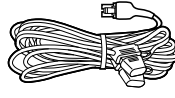

DC power cable

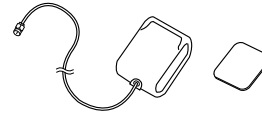

GPS antenna and
double-sided adhesive pad

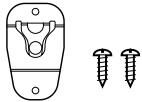

Microphone hanger and
screws (3 × 16 mm)

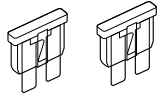

Spare fuse
(ATC 30A)



Spare fuse
(BFLP 5A)



Tuner connector kit



Accessory connector
(8-pin DIN)

Mounting bracket kit for the remote controller

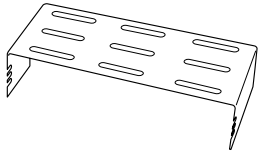

Mounting bracket

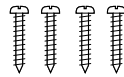

Self-tapping screws (M5)



Flat washers (M5)

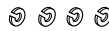

Spring washers (M5)



Screws (M5)

Mounting bracket kit for the main unit

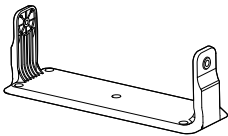

Mounting bracket

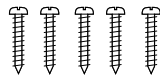

Self-tapping screws (M5)

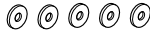

Flat washers (M5)



Spring washers (M5)

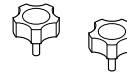

Knobs

NOTE: Some accessories are not supplied, or the shape is different, depending on the transceiver version.

■ Connections

◇ Connecting the microphone

1. Insert the microphone's connector into the microphone jack on the remote controller's front panel.
2. Rotate the connector clockwise until it is completely tightened.

CAUTION:

- Be sure that the microphone's connector is screwed in completely. Otherwise, the remote controller may lose its waterproof protection.
- **DO NOT** use non-Icom microphones. Other manufacturer's microphones have different pin assignments, and connection to the remote controller may damage it.

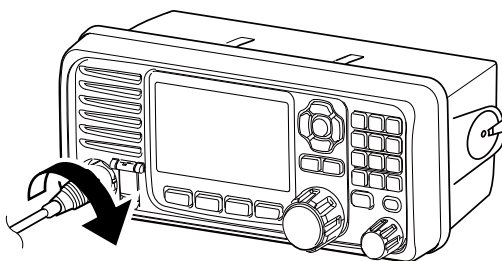

Microphone's
connector

◇ Connecting the remote control cable

1. Insert the remote control cable's connector into the main unit jack on the remote controller's back panel.
2. Rotate the connector clockwise until it is completely tightened.

CAUTION: Be sure that the control cable's connector is screwed to the remote controller's back panel completely. Otherwise, the remote controller may lose its waterproof protection.

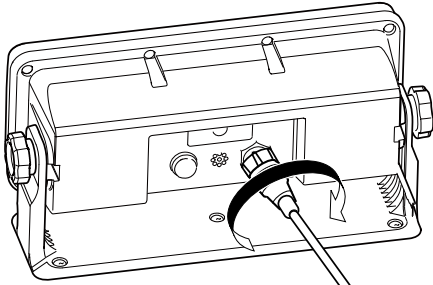

Remote controller cable's connector

◇ Front panel connections

CAUTION: When you connect an external unit, such as PC or e-mail modem, they must be properly grounded. (pp. 71 and 79)

NOTE:

- When an external speaker is connected, the internal speaker is automatically muted.

When a PC is connected:

- The PC being operated has priority at any given time.
- The remote controller is inhibited. Push **PC Mode Off**  on the remote controller screen to resume operation with it. (p. 15)
- The PC being operated automatically updates the settings of the remote controller.

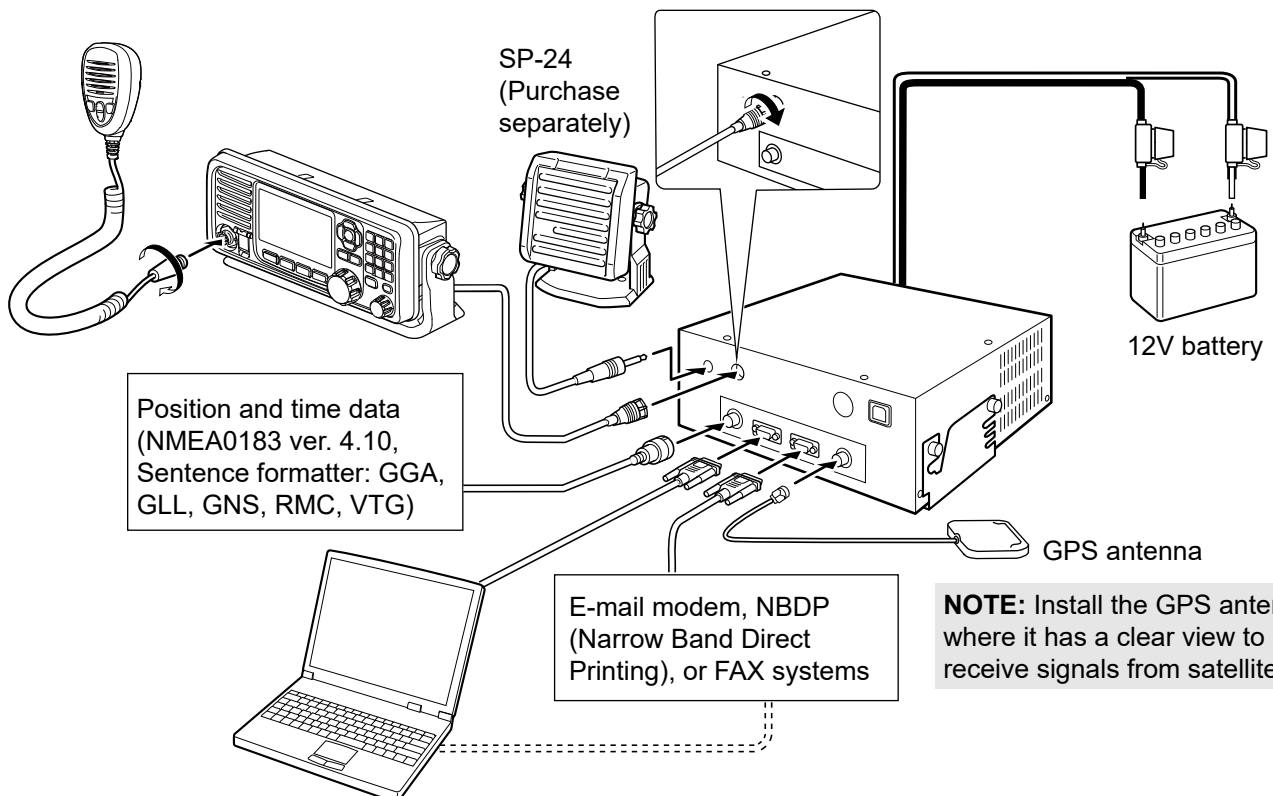

■ Connections

◇ Rear panel connections

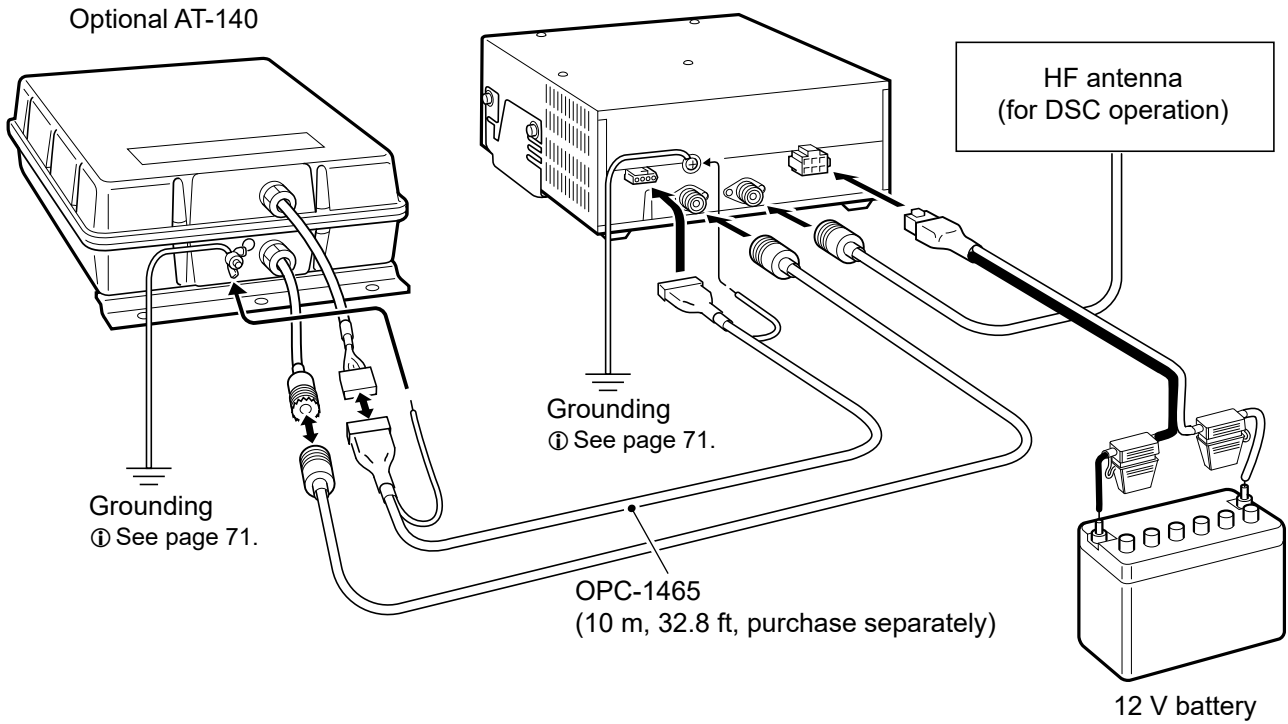

CAUTION:

- After connecting an antenna, tuner control cables, external speaker, or GPS receiver, cover the connectors with a rubber vulcanizing tape, as shown below, to prevent water seeping into the connection.
- **DO NOT** pull the antenna and control cable receptacles. It may cause cable disconnection (in the tuner unit), damage inside the connector, or a bad connection.

NOTE: Disconnect the battery from the IC-M803 Main unit, or charge the battery while at anchor, otherwise the battery may become exhausted.

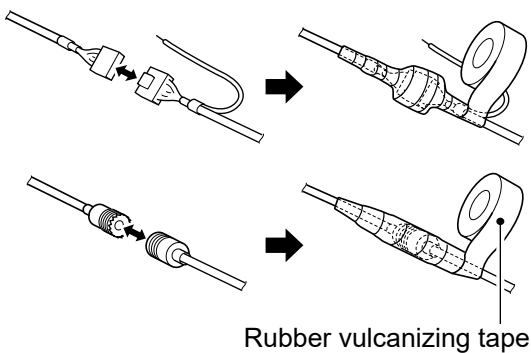

■ Ground connection

The transceiver and antenna tuner must have an adequate RF ground connection. Otherwise, the efficiency of the transceiver and antenna tuner may be reduced. Also, electrolysis, electrical shocks, and interference from other equipment may occur. For the best results, use a 50 or 75 mm (2 or 3 inches) wide copper strap, and make the connection as short as possible. Ground the transceiver and antenna tuner to one ground point, otherwise, the voltage difference (at the RF level) between the 2 ground points may cause electrolysis.

⚠ WARNING! When grounding to a metal hull, use Zinc anodes to protect the hull from electrolysis. Ask your dealer or installer for RF grounding details.

CAUTION:

- **NEVER** connect the transceiver to a “positive-grounded vessel,” otherwise the transceiver will not function.
- Any external units, such as PC, printer, and so on, must be properly grounded. We suggest using a wide copper strap.

Best ground points

- External ground plate
- Copper screen
- Copper foil

Acceptable ground points

- Stainless steel stanchion
- Through mast
- Through hull
- Metal water tank

Undesirable ground points

- Engine block
- Vessel’s DC battery ground

Unusable ground points

(these connections may cause an explosion or electrical shock)

- Gas or electrical pipe
- Fuel tank or oil catch pan

Ground system Example

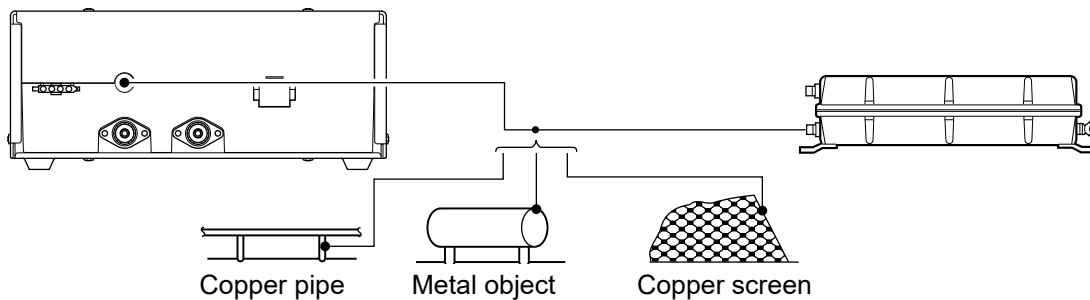

■ Power source

The transceiver requires a regulated DC power of 13.6 V and at least 30 A.

- Direct connection to a 12 V battery in your vessel through the supplied DC power cable.

CAUTION: The supplied DC power cable **MUST** be used to provide power to the transceiver. **AVOID** exceeding a 3 m (10 ft.) length of the DC power cable. When it is necessary to make a run of over 3 m, use a #6 or similar gauge wire with line fuses, instead of the supplied DC power cable. The cable should be a maximum of 6 m (20 ft.).

DC power cable connection

NOTE: Use terminals for the cable connection.

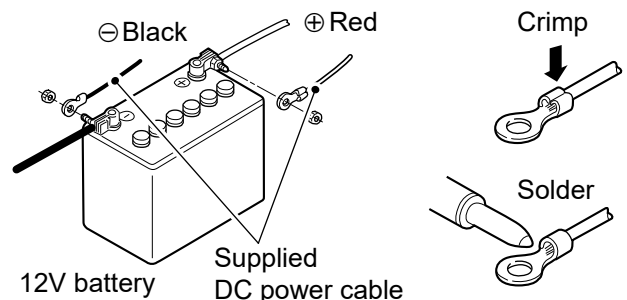

■ Antenna

Most stations operate with a whip or long wire antenna. However, these antennas cannot be connected directly to the transceiver since their impedance may not be matched with the transceiver antenna connector.

Even with a 50 Ω matched antenna, all marine bands may not be entirely usable. The following antenna matcher and antenna tuner may be helpful for proper antenna installation.

⚠ **DANGER HIGH RF VOLTAGE! NEVER** touch an antenna while transmitting. It may result in an electrical shock or burn.

◇ MN-100/MN-100L ANTENNA MATCHERS

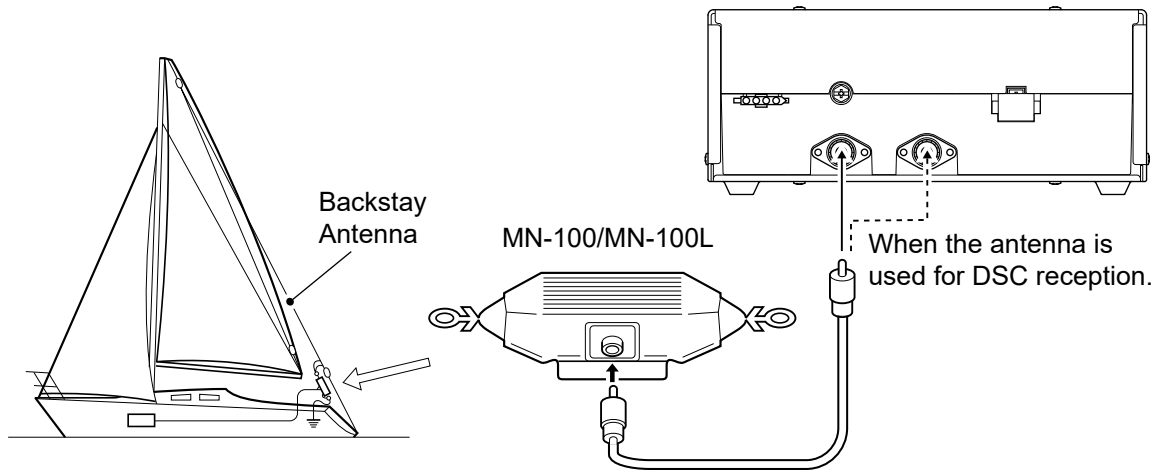

◇ AT-130/AT-120/AH-3 AUTOMATIC ANTENNA TUNER

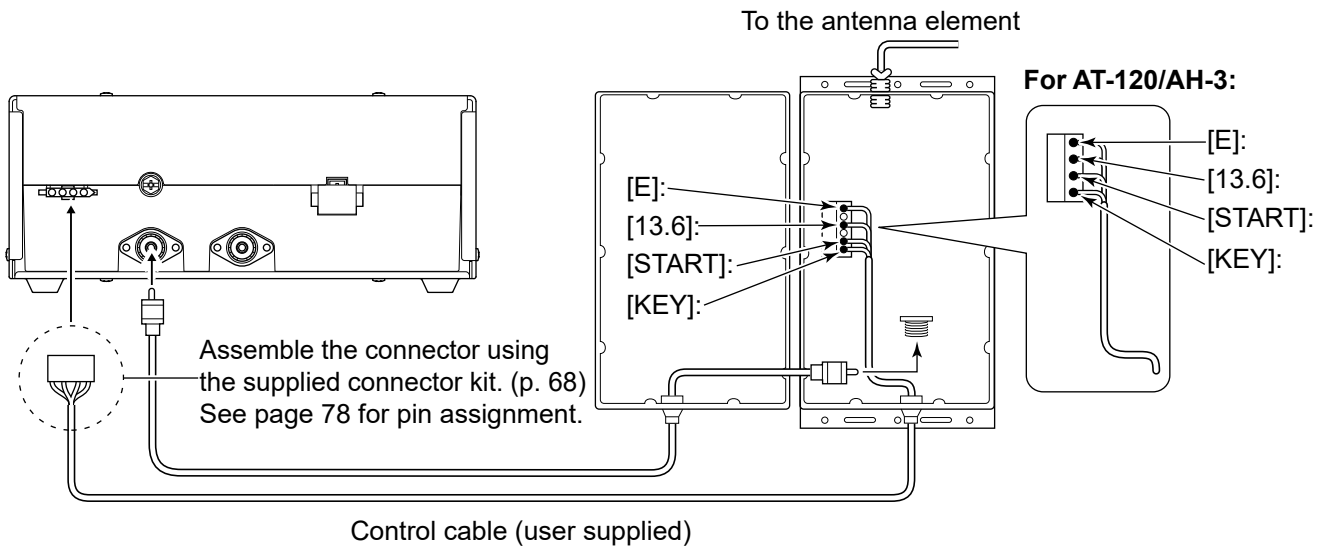

◇ Non-Icom Tuner

Some non-Icom tuners may be used with the IC-M803. Ask your dealer if you wish to connect one.

◇ AT-140 AUTOMATIC ANTENNA TUNER

See page 70.

■ Mounting

◇ Mounting location

Select a location that provides easy access to the controller for navigation safety, has proper ventilation, and is not subject to sea spray. The controller should be in your line of sight when operating it.

CAUTION: KEEP the transceiver and microphone at least 1 meter (3.3 ft) away from your vessel's magnetic navigation compass.

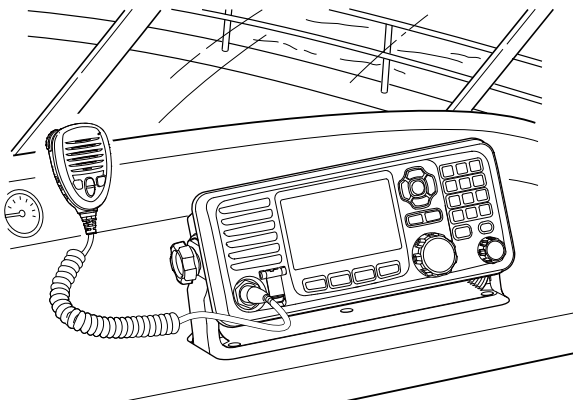

◇ Mounting the remote controller

You can mount the remote controller on a dashboard using the mounting bracket supplied with your transceiver.

1. Mount the bracket securely to a surface which is more than 10 mm thick and can support more than 2 kg (4.4 lb) using the 5 supplied screws (5 × 20 mm).
2. Attach the remote controller to the bracket so that the face of the remote controller is in your line of sight when operating it.
 - ① Adjust the function display angle to be easy-to-read.
3. Attach the supplied knobs to both sides of the remote controller.

Mounting Example

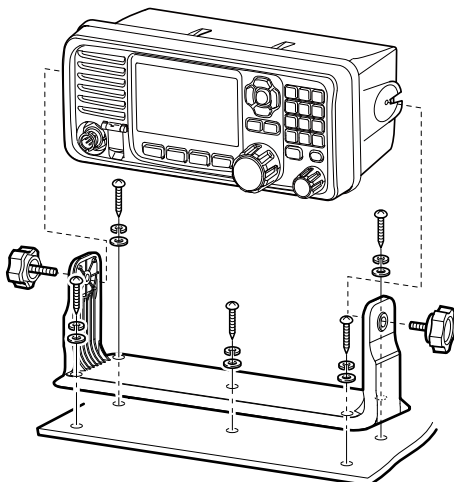

◇ Mounting the Main unit

You can mount the Main unit using the mounting bracket supplied with your transceiver.

⚠ WARNING! NEVER mount the transceiver's Main unit overhead. The weight of the Main unit is approximately 4.41 kg (9.7 lb), and it could easily fall due to wave shocks or vibration. The unit must be mounted on a flat hard surface only.

1. Mount the bracket securely to a surface and can support more than 10 kg (22 lb) using the 4 supplied screws (5 × 20 mm).
2. Attach the Main unit to the bracket.
3. Attach the 4 bolts (5 × 8 mm) supplied with the mounting kit to both sides of the Main unit. (Torque: 3 N•m)

Mounting Example

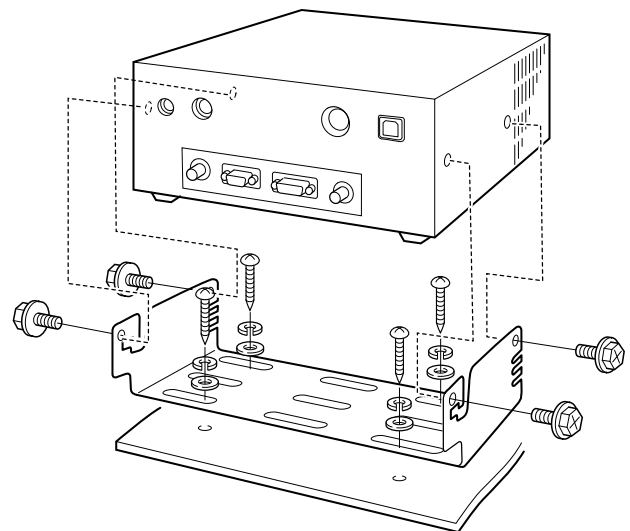

■ MB-75 installation

The optional MB-75 flush mount kit is for mounting the remote controller to a flat surface (less than 18 mm thick), such as an instrument panel.

1. Using the template on page 83, carefully cut a hole in the instrument panel, or wherever you plan to mount the remote controller.
2. Slide the remote controller through the hole, as shown to the right.

3. Attach the 2 bolts (5 × 8 mm) and spacer supplied with the MB-75 to both sides of the remote controller.

4. Attach the clamps on both sides of the remote controller.

① Make sure that the clamps align parallel to the transceiver body.

5. Tighten the end bolts on the clamps (rotate clockwise) so that the clamps press firmly against the inside of the instrument control panel.

6. Tighten the locking nuts (rotate counterclockwise) so that the transceiver is securely mounted in position, as shown to the right.

7. Connect the control cable, and then return the instrument control panel to its original place.

CAUTION: KEEP the transceiver and microphone at least 1 meter (3.3 ft) away from your vessel's magnetic navigation compass.

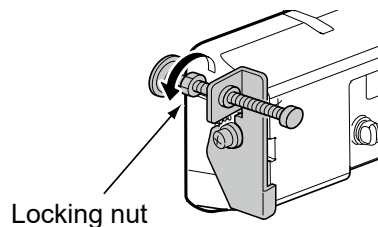
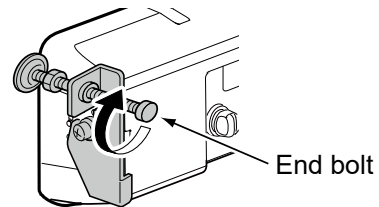
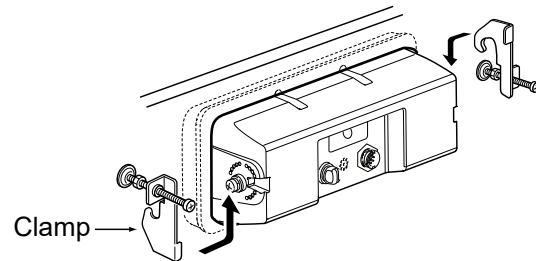
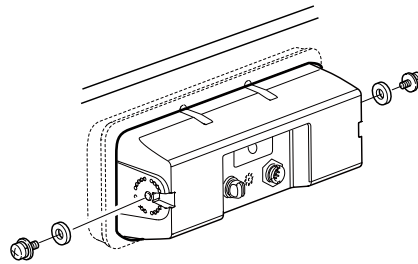
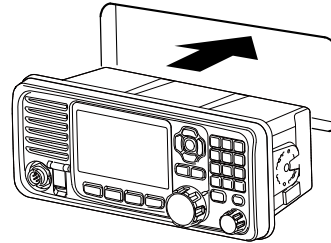

■ Transceiver dimensions

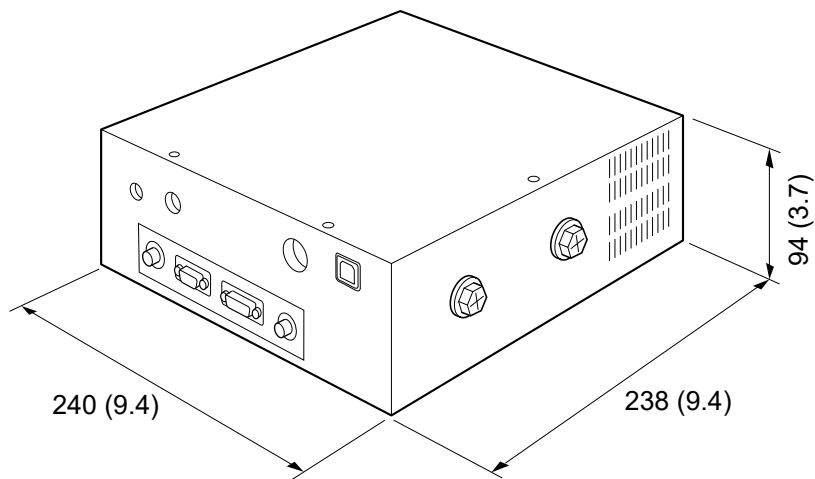
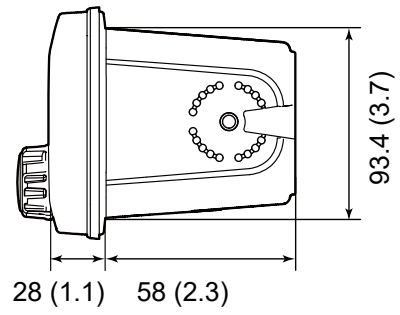
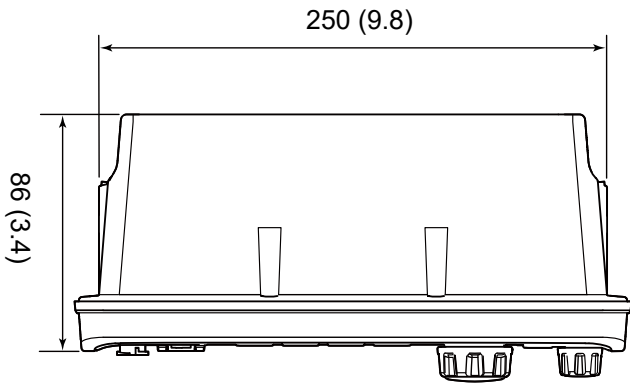
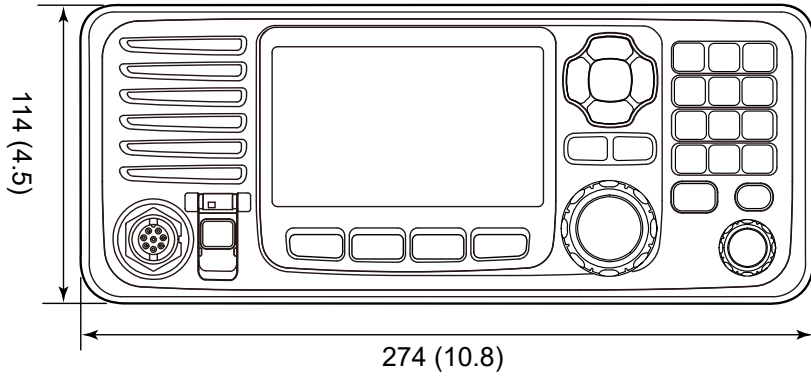

Unit: mm (inch)

■ Fuse replacement

◇ Circuitry fuse

The transceiver has two kind of fuses to protect internal circuitry.

Two fuses for the fuse holder on the DC power cable, and one for the Circuitry unit of the Main unit.

If the transceiver stops functioning, and only after confirming a fuse is probably blown, check the fuses below.

- DC power cable: ATC 30 A
- Circuitry unit: BFLP 5 A

1. Unscrew the 8 screws from the top cover as shown below, and then remove the cover.

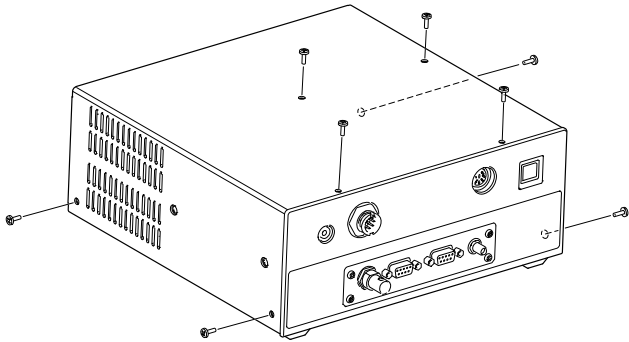

2. Unscrew 8 screws from the PA shield cover, then open the cover.
 - The cooling fan is fixed to the PA shield cover.
 - Move the coaxial cable, as shown in the diagram.
 - Be careful that the cooling fan power cables are still connected.

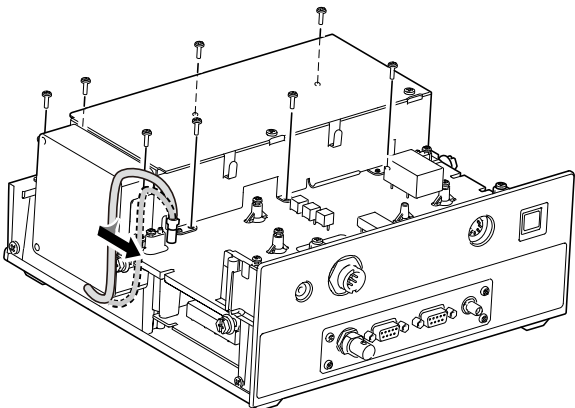

3. Replace the circuitry fuse, as shown in the diagram below.

CAUTION:

- Use the supplied BFLP 5 A fuse.
- When you remove a fuse, use longnose pliers to protect your fingers, and the fuse holders.

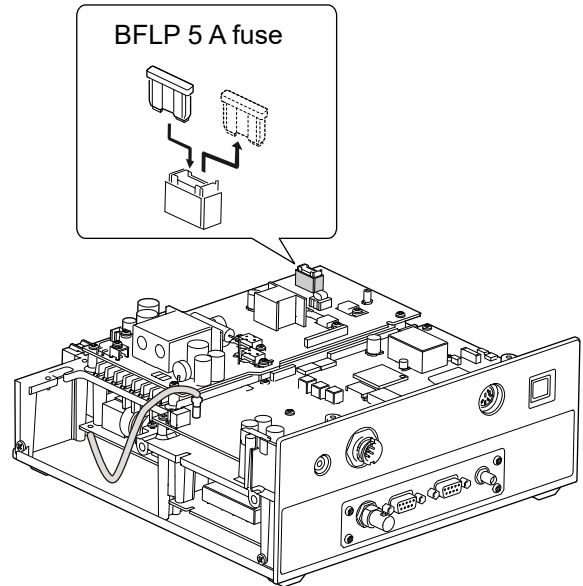

4. Replace the PA shield cover, coaxial cable and top cover.

◇ DC power cable fuses

If a fuse blows, or the transceiver stops functioning, find and repair the cause of the problem. Then replace the damaged fuse with a new adequately rated fuse.

① Spare fuses are supplied with the transceiver.

The fuses are installed in the DC power cable and in the inside circuitry, to protect the transceiver.

- DC power cable: ATC 30 A
- Circuitry unit: BFLP 5 A

⚠ WARNING!

- Disconnect the DC power cable from the Main unit before replacing the fuse.
- **NEVER** use fuses that are not specified.

See the following illustration to replace the DC power cable fuses.

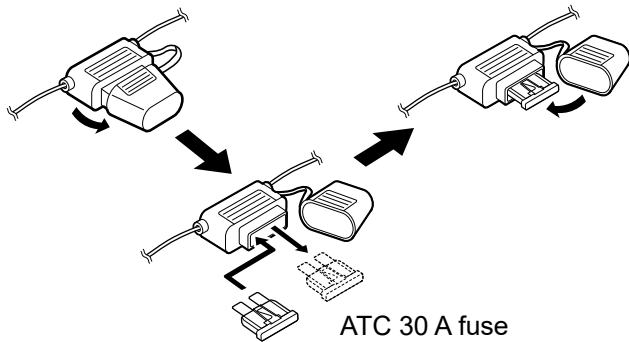

■ Connector information

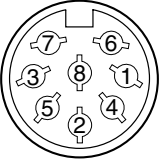
ACC	Pin	Pin name	Description	Specification
	1	CWK	CW and FSK keying input.	Input level: -0.5 to 0.8 V
	2	AF GND	Ground line for AF signal.	-
	3	SEND	Input/Output pin. Ground this pin to transmit.	Ground level: -0.5 to 0.8 V Input current: Less than 20 mA
	4	MOD	Modulator input. Usable when pin 3 is grounded.	Input impedance: More than 10 kΩ Input level: Approximately 100mV rms
	5	AF	AF detector output. Fixed, regardless of [VOL] position.	Output impedance: Less than 4.7 kΩ Output level: 100–300 mV rms
	6	NC	No connection.	-
	7	13.6 V	13.6 V output when power is ON.	Output current: Maximum 1 A
	8	ALC	ALC voltage input.	Control voltage: -3 to 0 V Input impedance: More than 10 kΩ
	*	DC GND	Common ground.	-

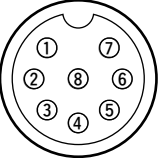
MICROPHONE	Pin	Pin name	Description	Specification
	1	MIC+	Audio input from the microphone element.	Input impedance: 1.74 kΩ ± 20 %
	2	NC	No connection.	-
	3	AF1	AF output controlled with [VOL]. Connected to pin 4 in the microphone.	-
	4	AF2	AF input. Connected to pin 3 in the microphone.	-
	5	PTT	PTT switch input.	When grounded, transmits.
	6	GND	Connected to the ground.	-
	7	MIC-	Coaxial ground for MIC+.	-
	8	AF-	Coaxial ground for AF1 and AF2.	-

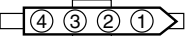
TUNER	Pin	Pin name	Description	Specification
	1	KEY	Key signal input.	-0.5 to 0.8 V during tuning.
	2	START	Start/Through signal output.	Pulled up 8 V, 0 V (100 msec) as a start signal.
	3	13.6 V	13.6 V output.	Maximum current: 2 A
	4	E	Negative ground.	Ground terminal for above signals.

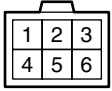
DC 13.6 V	Pin	Pin name	Description	Specification
	1-3	⊕	DC input ⊕.	Maximum power consumption: 30 A typical.
	4-6	⊖	DC input ⊖.	-

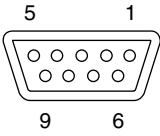
AF/MOD	Pin	Pin name	Description	Specification
	1	MOD+	Modulation input from an external terminal unit.	Input impedance: More than 600 Ω Input level: Approximately 0.77 V rms
	2	MOD-	Coaxial ground for MOD+.	–
	3	GND	Ground for digital equipment.	–
	4	AF+	AF detector output for an external terminal unit.	Output impedance: Less than 600 Ω Output level: More than 770 mV rms
	5	AF-	Coaxial ground for AF+.	–
	6	GND	Ground for digital equipment.	–
	7	NC	No connection.	–
	8	SEND	Ground this pin to transmit.	Ground level: –0.5 to 0.8 V Input current: Less than 20 mA
	9	GND	Ground for digital equipment.	–

9

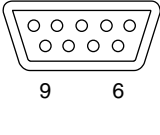
REMOTE	Pin	Pin name	Description
	1	DCD	Inputs terminal for carrier detection.
	2	RXD	Inputs terminal for receive data.
		NMEA-OUT	NMEA0183 ver 4.10 data output.
	3	TXD	Outputs transmit data.
		NMEA-IN	NMEA0183 ver 4.10 data input.
	4	DTR	Outputs data terminal ready signal.
	5	GND	Connected to ground.
	6	DSR	Inputs terminal for a data-set-ready signal.
	7	RTS	Outputs request-to-send data.
8	CTS	Inputs terminal for clear-to-send data.	
9	NC	No connection.	

GPS-DATA	Pin	Pin name	Description
	1	NMEA ⊕	NMEA0183 ver 4.10 data input ⊕.
	2	NMEA ⊖	Ground for NMEA data ⊕.

10 SPECIFICATIONS AND OPTIONS

■ Specifications

◇ General

- Frequency coverage:

RX	0.5 ~ 29.9999 MHz (Continuously)
TX	1.6 ~ 2.9999 MHz, 4.0 ~ 4.9999 MHz 6.0 ~ 6.9999 MHz, 8.0 ~ 8.9999 MHz 12.0 ~ 13.9999 MHz, 16.0 ~ 17.9999 MHz 18.0 ~ 19.9999 MHz, 22.0 ~ 22.9999 MHz 25.0 ~ 27.5000 MHz
- DSC (RX): 2.1875 MHz, 4.2075 MHz, 6.3120 MHz, 8.4145 MHz, 12.5770 MHz, 16.8045 MHz
- Mode:

RX/TX	J3E (USB/LSB), J2B (AFSK), F1B (FSK), A1A (CW)
RX only	H3E (AM)
DSC	J2B
- The number of user channels: 160
- The number of ITU SSB simplex channels: 72
- The number of ITU SSB duplex channels: 249
- The number of ITU FSK channels: 193
- The number of e-mail channels: 160
- Antenna connector: SO-239 × 2
- Antenna impedance: 50 Ω (Unbalanced)
- Frequency stability:

Transceiver	±10 Hz
DSC	±10 Hz
- Power supply requirement: 13.6 V DC ±15% (negative ground)
- Current drain:

RX	Less than 3.0 A (Maximum audio output)
TX	Less than 30 A (Maximum output power)
- Usable temperature range: -20°C ~ +55°C (-4°F ~ +131°F)
- Dimensions (projections not included):

Main unit	240 (W) × 94 (H) × 238 (D) mm, 9.4 (W) × 3.7 (H) × 9.4 (D) in
Controller	274 (W) × 114 (H) × 86 (D) mm, 10.8 (W) × 4.5 (H) × 3.4 (D) in
- Weight (approximately):

Main unit	4.41 kg (9.7 lb)
Controller	760 g (1.7 lb)

NOTE: The usable temperature ranges of the AT-140, AT-130, AT-120, and AH-3 ANTENNA TUNERS are different from the IC-M803.

- AT-140/AT-130/AT-120:
-30°C ~ +60°C (-22°F ~ +140°F).
- AH-3:
-10°C ~ +60°C (+14°F ~ +140°F).

◇ Transmitter

- Output power:
1.6 ~ 27.5000 MHz
150/100/60/20 W PEP (Selectable)
- Spurious emissions (at Maximum power):
Less than -62 dB for peak output power
- Carrier suppression (at Maximum power):
More than 40 dB for peak output power
- Unwanted sideband suppression (at Maximum power):
More than 55 dB for peak output power (with 1500 Hz AF Input)

◇ Receiver

- RX/TX sensitivity:

J3E, A1A	0.5 ~ 1.5999 MHz 30 dBμV emf (20 dB SINAD) / 16 dBμV (10dB S/N)
	1.6 ~ 1.7999 MHz 13 dBμV emf (20 dB SINAD) / -1 dBμV (10dB S/N)
	1.8 ~ 29.9999 MHz 8 dBμV emf (20 dB SINAD) / -6 dBμV (10dB S/N)
J2B, F1B	1.6 ~ 1.7999 MHz 4 dBμV emf (20 dB SINAD) / -10 dBμV (10dB S/N)
	1.8 ~ 29.9999 MHz -1 dBμV emf (20 dB SINAD) / -15 dBμV (10dB S/N)
H3E	0.5 ~ 1.5999 MHz 44 dBμV emf (20 dB SINAD) / 30 dBμV (10dB S/N)
	1.6 ~ 1.7999 MHz 30 dBμV emf (20 dB SINAD) / 16 dBμV (10dB S/N)
	1.8 ~ 3.9999 MHz 24 dBμV emf (20 dB SINAD) / 10 dBμV (10dB S/N)
- DSC sensitivity:

J2B	2.1875 MHz, 4.2075 MHz, 6.3120 MHz, 8.4145 MHz, 12.5770 MHz, 16.8045 MHz 6 dBμV emf (20 dB SINAD) / -8 dBμV (10dB S/N) / -6 dBμV emf (at 1% error rate)
-----	--
- Squelch sensitivity (S-meter):

J3E (at 12.230 MHz)	Less than +20 dBμV (threshold) Less than +90 dBμV (tight)
H3E (at 1.000 MHz)	Less than +30 dBμV (threshold) Less than +110 dBμV (tight)
- Spurious response rejection:

RX/TX	More than 70 dB (0.5 ~ 29.9999 MHz)
DSC	More than 70 dB
- Audio output power:
4 W at 10 % distortion into a 4 Ω load
- CLARITY variable range:
±150 Hz

① All stated specifications are subject to change without notice or obligation.

■ Options

◇ Antenna tuner

- **AT-130/AT-140** AUTOMATIC ANTENNA TUNER
Matches the transceiver to a long wire antenna with little insertion loss.

◇ Antenna

- **AH-710** FOLDED DIPOLE ANTENNA
Covers from 1.9 to 30 MHz band.
Has an SO-239 connector. Easy to assemble (non-kink construction).

◇ Antenna matcher

- **MN-100** ANTENNA MATCHER
Matches the transceiver to a dipole antenna.
Covers all HF bands from 1.5 to 30 MHz.
8 m (26.2 ft) × 2 antenna wires come attached.
- **MN-100L** ANTENNA MATCHER
Matches the transceiver to a long wire antenna.
Covers all HF bands from 1.5 to 30 MHz.
15 m (49.2 ft) × 1 antenna wire comes attached.

◇ Microphone

- **HM-214H** MICROPHONE
IPX8 waterproof, dynamic microphone.
Same as supplied.

◇ Others

- **SP-24** EXTERNAL SPEAKER
4×4 inch external speaker.
Input impedance: 4 Ω. Maximum input power: 7 W.
- **MB-75** FLUSH MOUNT KIT
To mount the controller or SP-24 EXTERNAL SPEAKER to a panel.
- **OPC-1465** SHIELDED CONTROL CABLE
10 m (32.8 ft) shielded control cable connects between the AT-140 and the transceiver.
- **CS-M803** PROGRAMMING SOFTWARE
- **OPC-478UC** PROGRAMMING CABLE

11 TROUBLESHOOTING

The transceiver does not turn ON.

- Bad connection to the power supply.
→Check the connection between the transceiver and the power supply. (p. 71)
- The fuse is blown.
→Repair the problem, and then replace the fuse. (pp. 76, 77)

Little or no sound comes from the speaker.

- Squelch level is set too high.
→Set the squelch (S-meter Squelch level) to the threshold point. (p. 18)
- Volume level is set too low.
→Set the volume level to a suitable level. (p. 4)

You cannot transmit or cannot select high power.

- Some channels are set for low power or receive only by regulations.
→Change channels. (p. 12)
- The output power is set to low.
→Push **TX Power**  to select high power. (p. 18)

No beep sounds.

- The Key Beep function is OFF.
→Turn ON the function. (p. 62)

The Main screen is not displayed at power ON.

- MMSI (DSC self ID) code is not set
→Set the MMSI (DSC self ID) code. (p. 9)

Individual or Group ID cannot be set.

- The entered ID code is incorrect. The first digit must be set to between '1' and '9' for an Individual ID.
→Enter a correct ID code. (p. 24)

“??” blinks instead of the position and time.

- 4 hours have passed since you manually entered the position.
- The GPS position is invalid.
→Enter the position and time. (p. 26)

“No Position” and “No Time” are displayed instead of the position and time.

- The GPS signal is not correctly received.
→Check the GPS antenna is located where it has a clear view to receive a signal from satellites. (p. 69)
→Check the cable connection to GPS-DATA or GPS-ANT. (p. 69, 79)
- The position and time have not been manually entered.
→Enter the position and time. (p. 26)

Sensitivity is too low, and only strong signals can be heard.

- The antenna is defective, or the coaxial cable connector is shorted or cut.
→Repair the problem, and then reconnect the antenna connector. (p. 70, 72)

The communication cannot be established.

- The antenna is defective, or the coaxial cable connector is shorted or cut.
→Repair the problem, and then reconnect the antenna connector. (p. 70, 72)

“The transceiver cannot receive or transmit. Contact your dealer” is displayed.

- The transceiver's Phase Lock Loop is unlocked.
→Contact your dealer.

The transceiver is locked up and does not respond.

- The software error has occurred.
→The transceiver will automatically restart after approximately 10 seconds has passed.

Cut here

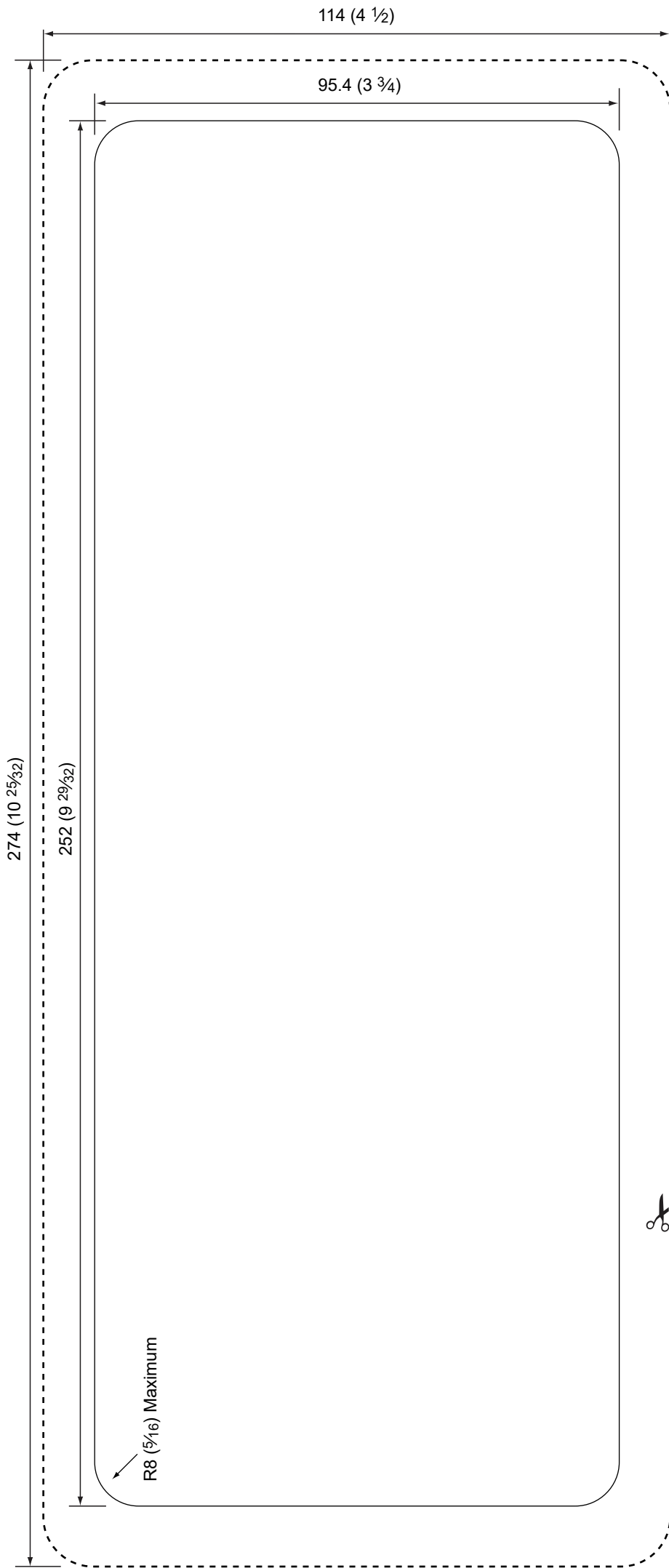

Unit: mm (inch)

A		
Accessories	68	
Alarm Status (DSC Settings)	58	
Antenna	72	
AT-130/AT-120/AH-3	72	
AT-140	70	
Auto ACK (DSC Settings)	57	
Automatic Gain Control OFF	19	
Auto Tune (Radio Settings)	65	
B		
Backlight	16	
Configuration	62	
C		
Channel		
Edit	21	
Group	12	
Selecting	12	
CH Auto Switch (DSC Settings)	58	
Clarity Control function	19	
Connections		
CW key	14	
Front	69	
FSK terminal unit	14	
Rear	70	
Remote control cable	69	
Connector information	78	
CW break-in (Radio Settings)	67	
CW operation	14	
D		
Dimensions	75	
Distress Acknowledgment		
Receiving	45	
Distress call		
Receiving	44	
Regular call	30	
Resending call	31	
Simple call	29	
Distress Cancel call		
Receiving	45	
Sending	32	
Distress key	4	
Distress Relay Acknowledgment		
Receiving	47	
Sending	34	
Distress Relay call		
Receiving	46	
DSC		
Address ID	24	
Frequency	55	
Log, received	54	
Log, transmitted	54	
DSC Scan	13	
DSC Task mode		
Multiple	28	
Single	27	
E		
e-mail		
Channel	21	
Filter	15	
Operation	15	
Emergency FREQ channel	18	
External Tuner (Radio Settings)	65	
F		
FSK operation	14	
FSK (Radio Settings)	66	
Function display		
Channel area	7	
Information area	7	
Position and Time area	8	
Software key area	8	
Status area	7	
Task area	7	
Fuse replacement		
Circuitry	76	
DC power cable	77	
G		
Geographical Area call		
Receiving	51	
Sending	39	
GPS (Configuration)	63	
Ground connection	71	
Group call		
Receiving	50	
Sending	37	
Group ID		
Deleting	25	
Entering	24	
H		
HM-214H	5	
Assigning	23	
Connecting	68	

INDEX

I		R	
IF Filter (Radio Settings).....	66	Radio Information	67
Indicators	7	Receiving.....	13
Individual Acknowledgment		Remote (Configuration)	64
Receiving.....	49	Remote controller	
Sending	36	Panel description.....	4
Individual call		RF Gain Level.....	18
Receiving.....	48		
Sending	35		
Individual ID			
Deleting	25		
Entering	24		
Instrant Replay (Radio Settings).....	67		
ITU FSK channel	66		
ITU Simplex channel	21		
M		S	
Main screen	7	Scan	
Main unit		CH	16
Front	2	CH Resume	16
Rear.....	3	Program.....	17
Max User CH (Radio Settings).....	65	Radio Settings	65
MB-75 installation	74	Scanning Receiver (DSC Settings)	
Menu screen		Distress	56
Construction	10	Routine	57
Selecting the item.....	11	Self Check Test (DSC Settings).....	60
MMSI code, entering	9	S-meter Squelch Level	18
MN-100/MN-100L	72	Software Keys	
Mounting		Assigning	22
Location.....	73	Functions	6
Main unit.....	73	Selecting.....	5
Remote controller	73	Speaker Output	19
		Specifications	80
		Squelch function	18
N		T	
NMEA Data Output (DSC Settings).....	58	Temporary Operating Frequency.....	20
Noise Blanker function.....	18	Test Acknowledgment	
Noise Blanker Level.....	18	Receiving.....	53
Noise Reduction (Radio Settings)	65	Sending	43
		Test call	
		Receiving.....	52
		Sending	42
		Time-out Timer function.....	13
		Transmit Frequency Monitor function	19
		Transmitting	13
		TX Power.....	18
O		U	
Operating rules	1	User channel	21
Options	81		
P		V	
Position		Voice Recorder	17
Entering	26	Voice Scrambler Code (Radio Settings).....	66
Input (DSC Settings)	55	Voice Scrambler function.....	19
Power source.....	71	Voice SQL (Radio Settings).....	66
Procedure (DSC Settings).....	60	Volume Dial	
		Assigning.....	23
		Function.....	4

Count on us!

